



Features

- Hands-free usage increases hygiene
- Sensor positioned underneath the spout head for more accurate user detection
- WATER SAVING
- ECO CAP Technology:
TOTO aerated bubble technology adds air to the water to achieve full water jet

Specifications

Flow Rate: 1.3L/min
 Water Pressure: 0.05MPa ~ 0.75MPa
 Finish: Nickel Chrome

Parts description

- TLE28001T-AC
 AUTO FAUCET (AC220~240V)
1. TLE28001 (Deck-mounted)
 2. TLE01502 (AC Operated Controller)

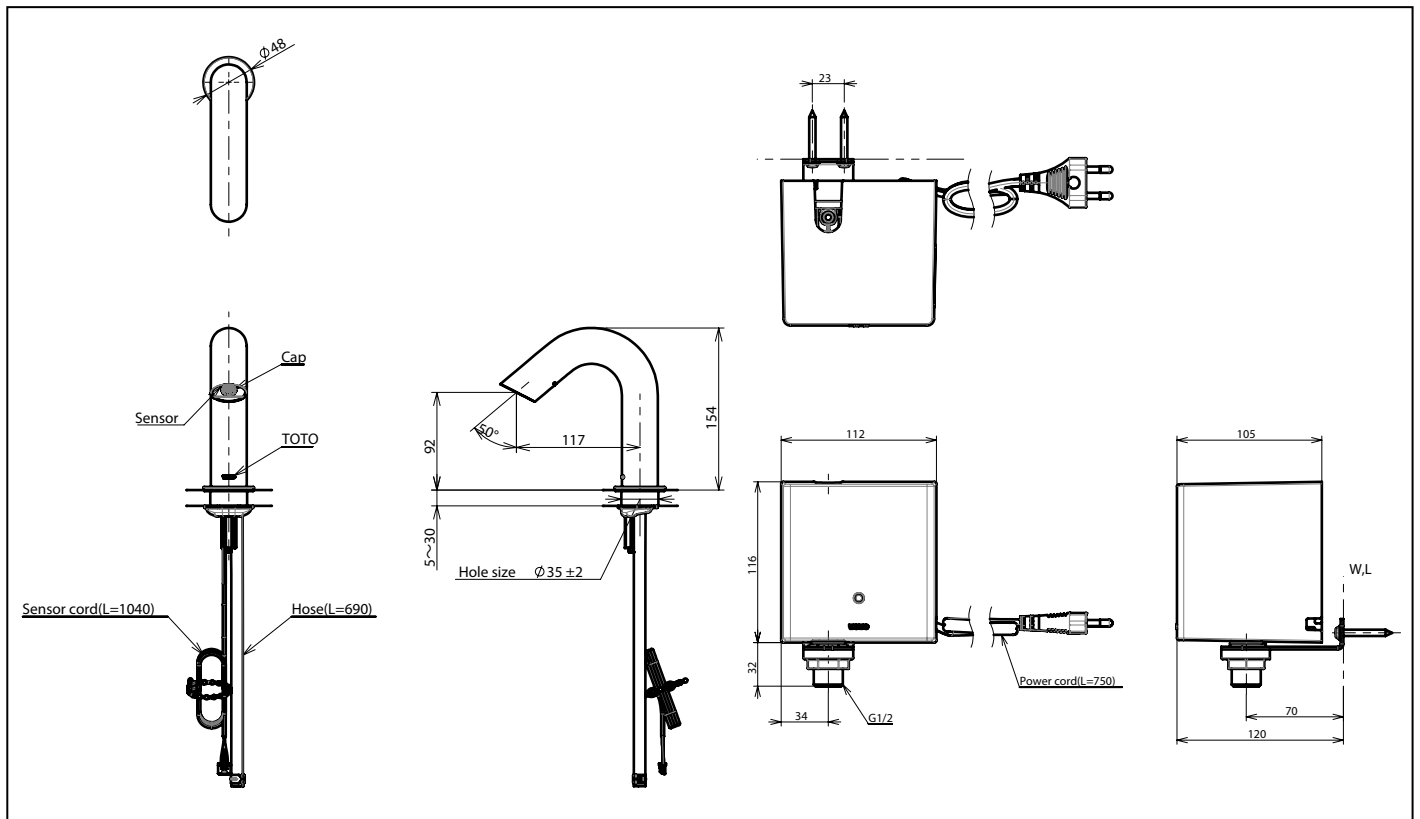

Remarks: Please result TOTO sales representative for detail.