



Features

- Hands-free usage increases hygiene
- Sensor positioned underneath the spout head for more accurate user detection
- ECOPOWER Technology
Self-generated power saves electricity
- WATER SAVING
- ECO CAP Technology:
TOTO aerated bubble technology adds air to the water to achieve full water jet

Specifications

Flow Rate: 1.3L/min
 Water Pressure: 0.05MPa ~ 0.75MPa
 Finish: Nickel Chrome

Parts description

TLE25002T-EC

AUTO FAUCET (ECOPOWER)

1. TLE25002 (Deck-mounted)
2. TLE0350 (ECOPOWER Controller)



reddot winner 2021

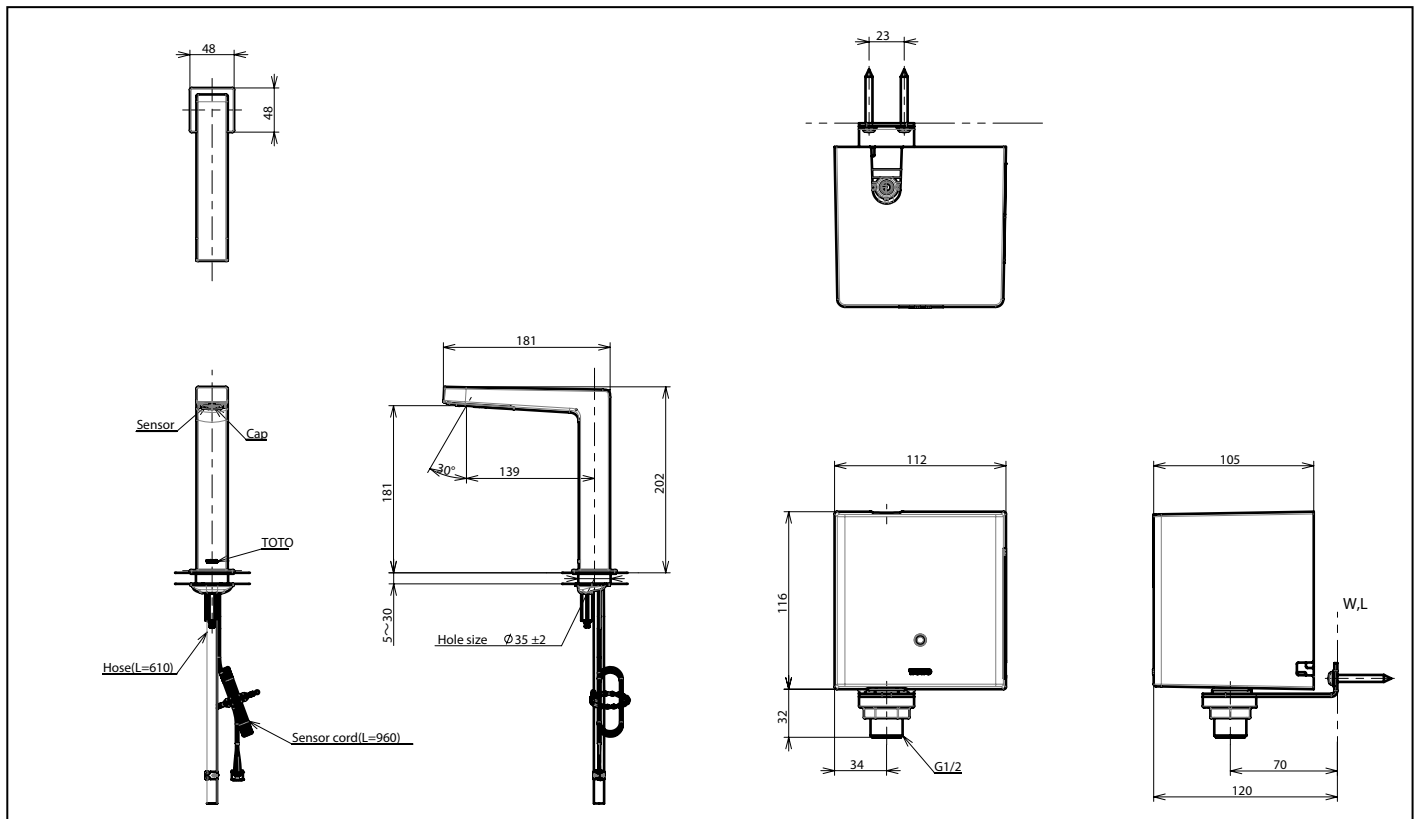

Remarks: Please result TOTO sales representative for detail.