

TOTO

TOTO U.S.A., Inc. 1155 Southern Road Morrow, GA 30260
Phone : (770) 282 8686

Warranty Registration and Inquiry

For product warranty registration, TOTO U.S.A. Inc. recommends On-Line Warranty Registration. Please visit our web site <http://www.totousa.com>. If you have questions regarding warranty policy or coverage, please contact TOTO U.S.A. Inc., Customer Service Department, 1155 Southern Road, Morrow, GA 30260 (888) 295 - 8134 or (678) 466 - 1300 when calling from outside of U.S.A.

TOTO ASIA OCEANIA PTE. LTD. 10, Eunost Road 8, #12-07, Singapore Post Centre. Singapore 408600.
Phone : +65-6744-6955 Fax : +65-6841-0819 <http://asia.toto.com/>

TOTO ASIA OCEANIA PTE. LTD. Middle East Branch LOB19-1701-1702, Jebel Ali Free Zone, P.O. box 261804, Dubai U.A.E.
Phone : +971-4-886-5983 Fax : +971-4-886-5986 <http://asia.toto.com/>

TOTO ASIA OCEANIA PTE. LTD. Manila Representative Office. Unit 1010, 10th Floor Rufino Building, Ayala Avenue cor.V.A. Rufina Street, Makati City, 1226 Philippines.
Phone : +63-2-887-6643 Fax : +63-2-887-4084 <http://asia.toto.com/>

TOTO LTD. Bangkok Representative Office G Floor, Q.House Ploenjit Building, 598 Ploenchit Road, Lumpini, Pathumwan, Bangkok 10330 Thailand
<http://www.totobkk.com>

TOTO INDIA INDUSTRIES PVT. LTD Head office 506, 5th Floor, ASCOT Center, Sahar Airport Road, Andheri (East) Mumbai 400099, Maharashtra, India.
Phone : +91-22-2832-5741/5742 Fax : +91-22-6725-8780 <http://asia.toto.com/>

TOTO INDIA INDUSTRIES PVT. LTD Delhi Branch 909-909A, 9th Floor, Block-E, International Trade Tower, Nehru Place, New Delhi 110019, India.
Phone : +91-11-4654-2421 to 26 Fax : +91-11-4654-2430 <http://asia.toto.com/>

TOTO VIETNAM Co., Ltd. Ha Noi Branch R. 810, Daeha Business Centre, 360 Kim Ma St., Ba Dinh Dist., Ha Noi City
Phone : +84-4-37714354 Fax: +84-4-37714355 <http://toto.com.vn>
Da Nang Branch 10th Floor, ACB Building, 218 Bach Dang Str., Hai Chau Dist., Da Nang City
Phone : +84-511-3565261 Fax: +84-511-3565262 <http://toto.com.vn>
Ho Chi Minh Branch R. 1301, Centec Tower, 72-74 Nguyen Thi Minh Khai Str., Dist. 3, Ho Chi Minh City
Phone : +84-8-38229520 Fax: +84-8-38229522 <http://toto.com.vn>

- You are advised to record the following information to allow quick service.

Date of purchase :	Name of shop :
Date : year month day	Tel : ()

2012.6.12
D08706

TOTO

Instruction Manual with Warranty

WASHLET



washlet

S350e SW584 (TCF4731U)
SW583 (TCF4730U)
S300e SW574 (TCF4721U)
SW573 (TCF4720U)



washlet

TCF4732A
TCF4731A

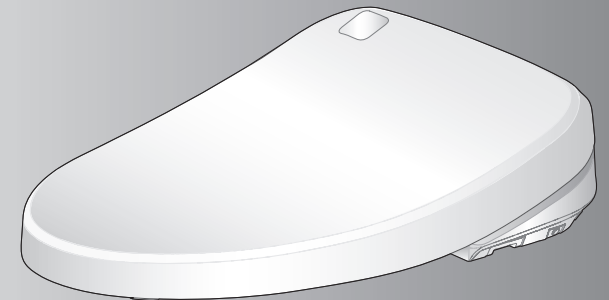

- Thank you for your recent purchase of the TOTO Washlet. Please read the enclosed information to ensure the safe use of your product.
- Be sure to read this Instruction Manual before using your product and keep it in a safe place for future reference.

What functions are available on your product?

The model name and part number are indicated on the bottom side of the toilet lid.



The available functions vary according to the model.

Functions		Model			Ref. Page	
		S350e	S300e	—		
		Part No.	SW584 SW583	SW574 SW573	TCF4732A TCF4731A	
Basic Functions	Cleaning	Rear cleansing		●		18
		Soft rear cleansing		●		
		Front cleansing		●		
		Wide front cleansing		●		
	Changing the washing method	Wand position adjustment		●		
		Water pressure adjustment		●		
		Oscillating cleansing		●		
		Pulsating cleansing		●		
Drying	Warm Air Drying		●		26	
Changing the temperature	Temperature Adjustment		●			
Convenient Functions	Opening and closing	Opening and closing the toilet seat with remote control	●	—	●	18
		Auto lid opening and closing	●	—	●	22
	Lighting up	Soft light	●	—	●	
	Heating the toilet seat	Heated seat		●		—
	Saving energy	Timer energy-saver		●		28
Auto energy-saver			●			
Sanitary Functions	"ewater+" sanitizing	Auto wand cleaning		●		24
		Auto bowl cleaning		●		
	Removing odors	Deodorizer		●		
Maintenance	Main Unit			●		34
	One-touch removal			●		35
	Removable toilet lid			●		
	Wand cleaning			●		36

Cleaning Support Sanitary Toilet

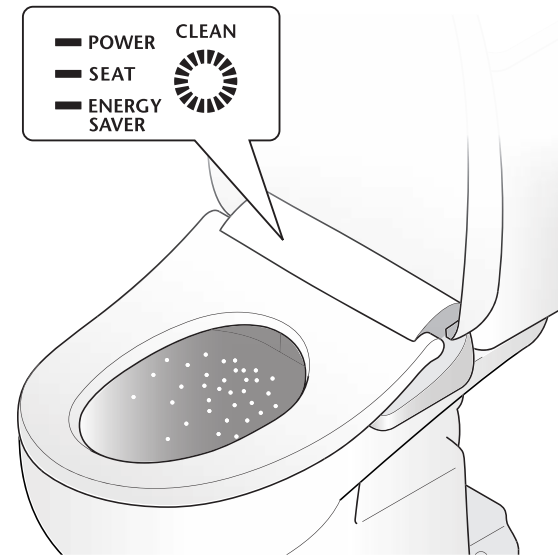
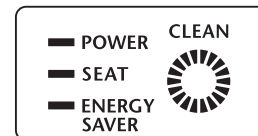

The self-cleaning functions operate automatically. (See pages 24 and 25 for details.)

As you approach As you stand up As you move away

- A mist is sprayed in the toilet bowl to make it more difficult for dirt to adhere.
- When you sit on the toilet seat, the deodorizer operates.
- The wand is cleaned with "ewater+". (The wand extends and then retracts.)
- "ewater+" is sprayed in the toilet bowl to maintain cleanliness.

Table of Contents

Safety Precautions.....	4	Introduction
Operational Precautions.....	11	
Parts Names	12	
Preparation	16	

Basic Operations.....	18	Operation
Automatic Functions (Convenience Features)	22	
Automatic Functions (Cleaning Features)	24	
Temperature Adjustment	26	
Energy-Saver Features	28	



Power Plug.....	32	Maintenance
Main Unit	33	
Deodorizing Filter	33	
Gap between the Main Unit and the Toilet Bowl.....	34	
Gap between the Main Unit and the Toilet Lid.....	35	
Wand	36	
Water Filter Drain Valve	37	

Changing Settings.....	38	Reference
What to Do?	50	
● If you cannot operate with the remote control	50	
● Freeze Damage Prevention	51	
● Long Periods of Disuse	52	
Troubleshooting	53	
Specifications	58	
Warranty	60	



Safety Precautions

These precautions are important for safe usage. Be sure to follow them and use the product correctly.

Symbols and meanings

 WARNING	May result in death or serious injury.
 CAUTION	May result in injury or property damage.



The following symbols are used to indicate important safety instructions for the use of the product.

Symbol	Definition
	This symbol indicates a prohibited use of the product.
	This symbol is used to indicate a required step in the use of this product.

 **WARNING**

	<p>Do not plug or unplug the power plug with wet hands.</p> <ul style="list-style-type: none"> • Doing so may cause electrical shock. <p>Do not get any water or cleaning products on the main unit or power plug.</p> <ul style="list-style-type: none"> • Doing so may cause a fire, electrical shock, heat or a short. • Doing so can cause the product to crack resulting in injury or water damage. <p>Never disassemble, repair or alter.</p> <ul style="list-style-type: none"> • Doing so may cause a fire, electrical shock, heat or a short. <p>Do not install the Washlet on moving vehicles such as RV's or boats.</p> <ul style="list-style-type: none"> • Doing so could cause a fire, electric shock, a short or malfunction. • The toilet seat, lid, main unit or other part might come loose and fall apart, resulting in injury. <p>Do not use the Washlet if a malfunction occurs.</p> <p>[USA] In the following cases, unplug the plug out from the outlet and close the water supply valve.</p> <p>[Asia, Oceania] In the following cases, switch the breaker on the distribution board to OFF and close the water supply valve.</p> <p>Possible malfunctions:</p> <ul style="list-style-type: none"> - Water is leaking from a pipe or the main unit - The product is cracked or broken. - The product makes a strange noise or emits a strange odor. - The product emits smoke. - The product is abnormally hot. - The toilet seat cushion is out of place. <ul style="list-style-type: none"> • Continued use after malfunction could cause a fire, electrical shock, heat, short, injury or water damage.
---	--

 **WARNING**

	<p>Only use tap water or potable well water (underground water). Do not use seawater.</p> <ul style="list-style-type: none"> • Doing so may cause irritation to the skin and malfunction. <p>Do not touch the power plug during thunderstorms.</p> <ul style="list-style-type: none"> • Doing so may cause electrical shock. <p>Do not allow the water supply hose to touch the power plug or outlet.</p> <ul style="list-style-type: none"> • Doing so may cause condensation resulting in a fire, electrical shock, heat or a short. <p>Do not do anything that could damage the power cord, power plug or toilet seat cord.</p> <p>Do not strike, yank, twist, excessively bend, damage, alter, or heat the electrical cords. Also, do not place anything heavy, bind or pinch the electrical cords.</p> <ul style="list-style-type: none"> • Using a damaged electrical cord may result in a fire, electrical shock, heat or short. <p>Do not use a loose or faulty electrical outlet.</p> <ul style="list-style-type: none"> • Doing so could cause a fire or a short. <p>Do not use any outlet or wiring equipment beyond its specified rating.</p> <ul style="list-style-type: none"> • Plugging too many plugs into the same outlet, for example using outlet splitters, can cause fire due to heat. <p>Do not use any power supply other than the one specified.</p> <p>[USA] AC 120 V, 60Hz</p> <p>[Asia, Oceania] AC 220 V, 50/60Hz</p> <ul style="list-style-type: none"> • Doing so could cause a fire or excessive heat. <p>Do not stick a finger or anything else into the warm air outlet.</p> <p>Do not place anything on the warm air outlet or drape clothes over it.</p> <ul style="list-style-type: none"> • Doing so could cause burns, electrical shock or malfunction.
	<p>Beware of low-grade burns</p> <ul style="list-style-type: none"> • Improper use of heated toilet seats could cause a low-grade burn. <p>When sitting for a long time on the toilet seat, switch the toilet seat temperature adjustment to "OFF".</p> <p>When any of the following persons use a heated seat or warm air drying, someone should switch the toilet seat temperature adjustment to "OFF" and switch the drying air temperature to "Low".</p> <ul style="list-style-type: none"> - Young children, the aged and other users unable set the temperature appropriately themselves - The ill, physically disabled and others who do not have freedom of movement - Those using any medicines that cause drowsiness (sleeping medicine or cold medicine), those who have been drinking heavily, anyone severely fatigued and anyone else liable to fall asleep <p>Always connect the Washlet to the cold water supply.</p> <ul style="list-style-type: none"> • Connecting to hot water supply may result in burns and equipment damage. <p>Make sure that a properly grounded (3 prong) outlet has been installed.</p> <ul style="list-style-type: none"> • Failure to install a grounded outlet could cause electrical shock in the event of a malfunction or short circuit.

Safety Precautions (Continued)

WARNING

Do not unplug by pulling the cord.

To unplug, hold the plug, not the cord.

- Pulling on the cord may cause damage and result in fire or heat.

This is an electrical product. Do not install it anywhere water is likely to get on the product or anywhere with humidity high enough that water is likely to form on the surface of this product. When using the product in a bathroom, install a fan or ventilation port and ensure good air flow through the bathroom.

- Failure to do so could cause a fire or electrical shock.

If the electric cord is damaged, avoid danger by having the manufacturer's repair department or equivalent specialist replace it.

Insert the power plug securely into the outlet.

- Failure to do so could cause a fire, heat or a short.

[USA]

Periodically remove dust and dirt from the electrical plug and make sure it is securely plugged into the wall outlet.

- Failure to do so could cause a fire, heat or a short.
Pull the plug out from the outlet and wipe clean with a dry cloth.

Always unplug the plug from the outlet before cleaning or maintenance.

- Failure to do so may cause electrical shock.
- Except when using "Wand cleaning"

Always unplug the plug from the outlet before removing the main unit.

- Failure to do so could cause a fire or electrical shock.

[Asia, Oceania]

Check that the power plug is waterproofed with silicone rubber.

- A power plug that is not water-proofed could cause a fire and electrical shock.
* If the power plug is not water-proofed, ask the contractor who did the installation to water-proof it.

Check that an appropriate ground is installed.

- If the ground is not installed, if there is a breakdown or electrical current leak, the lack of a ground could cause electrical shock.
For the ground, use copper wire with a ground resistance of 100 Ω max. and a diameter of 0.005 ft (1.6 mm) min.
* If there is no ground installed, ask the contractor who did the installation to install a ground.

Check that the outlet for electrical power is as follows.

- Failure to do so could cause a fire or electrical shock.
 - a. Protect the outlet circuits with a high-sensitivity quick leakage switch (with a rated current sensitivity of 15mA or less) or an insulating transformer (1.5kVA min., 3kVA max.).
 - b. Install the outlet and plug positioned at least 2.62 ft (0.8 m) above the floor and as far as possible from the bathtub.
* Check that the wiring in a. and b. above is complete. If the wiring has not been completed, ask the contractor who did the installation to do it.



WARNING

[Asia, Oceania]

Always switch the breaker on the distribution board to OFF before cleaning or maintenance.

- Failure to do so may cause electrical shock.
- Except when using "Wand cleaning"

Always switch the breaker on the distribution board to OFF before removing the main unit.

- Failure to do so could cause a fire or electrical shock.



CAUTION

Keep cigarettes and other open flames away from this product.

- Failure to do so could cause a fire.

When cleaning or maintaining the plastic parts (main unit etc.) or the water supply hose, use a kitchen cleaner diluted with water. Do not use any of the following.

Toilet cleaner, household cleaner, benzene, paint thinner, powdered cleanser or nylon scrubbing pads.

- These items could damage or crack the plastic and cause injury or malfunction.
- These items could damage the water supply hose and cause a water leak.

Do not apply strong force, mechanical shock, step on or stand on the toilet seat, toilet lid or main unit. Also do not place any heavy object on the toilet seat, toilet lid or main unit.

- Doing so could cause cracking or cause the main unit to come loose and fall resulting in injury.
- Doing so could damage the product and cause injury or water damage.

Do not lift up this product by the toilet seat or lid.

Do not raise the toilet seat or lid while objects are resting on top of the toilet.

- Doing so could cause the main unit to come loose and fall resulting in injury.

Do not fold or crush the water supply hose.

- Doing so could cause water leaks.

To prevent a sudden water leak, do not remove the water filter drain valve when the water supply valve is open.

- Doing so will cause water to spurt out.
Refer to Page 37 for instructions on cleaning the water filter drain valve.

Do not install the base plate, which is not attached, to the Washlet.

- Doing so could cause a fire or damage.

Do not use the product if the main unit is unstable.

- Doing so could cause the main unit to come loose and fall resulting in injury.



Safety Precautions (Continued)

CAUTION

If a water leak should occur, always close the water supply valve.

Preventing damage to pipes and hoses due to freezing

- Frozen water pipes could cause the main unit and the pipes to break, resulting in a water leak.
Regulate the room temperature to prevent the pipes and hoses from freezing during cold months.

[USA]

When not using the Washlet over an extended period of time, drain the water out of the Washlet and the water supply hose, and pull the electrical plug from the outlet.

When using the product again, allow the product to refill with water first.

- Otherwise, the water in the tank might become contaminated and cause skin inflammation or other problems.
- Leaving the power ON might cause a fire or heat.

[Asia, Oceania]

When not using the Washlet over an extended period of time, drain the water out of the Washlet and the water supply hose, and switch the breaker on the distribution board to OFF.

When using the product again, allow the product to refill with water first.

- Otherwise, the water in the tank might become contaminated and cause skin inflammation or other problems.
- Leaving the power ON might cause a fire or heat.

When installing the water filter drain valve, make sure that it is securely tightened in its proper position.

- Failure to securely tighten it might cause water leaks.

Push the main unit securely on to the base plate.

After pushing the main unit until a click sound is heard, pull it slightly toward you to make sure that the product does not detach.

- Failure to do so could cause the main unit to come loose and fall resulting in injury.

DANGER To reduce the risk of electrocution:

1. Do not use while bathing.
2. Do not place or store the product where it can fall or be pulled into a tub or sink.
3. Do not place in or drop into water or other liquid.
4. Do not reach for the product when it has fallen into water. Unplug immediately.

DANGER To reduce the risk of burns, electrocution, fire or injury to persons:

1. Close supervision is necessary when this product is used by, on, or near children or invalids.
2. Use this product only for its intended use as described in this manual. Do not use attachments not recommended by the manufacturer.
3. Never operate this product if it has a damaged cord or plug, is not working properly, has been dropped or damaged, or has been dropped in water. Return the product to a service center for examination and repair.
4. Keep the cord away from heated surfaces.
5. Never block the air openings on the product or place it on a soft surface, such as a bed or couch, where the air openings may be blocked. Keep the air openings free of lint, hair, and other similar items.
6. Never use while sleepy or drowsy.
7. Never drop or insert any object into any opening or hose.
8. Do not use outdoors. Do not operate where aerosol (spray) products are being used or where oxygen is being administered.
9. Connect this product to a properly grounded outlet only.
See "Grounding Instructions" in Page 10.
10. Tank should be filled with water only.

Safety Precautions (Continued)

Grounding Instructions

This product should be grounded. In the event of an electrical short circuit, grounding reduces the risk of electric shock by providing an escape wire for the electrical current.

The plug must be plugged into an outlet that is properly installed and grounded.

⚠ DANGER - Improper use of the grounding plug can result in a risk of electric shock. If repair or replacement of the cord or plug is necessary, do not connect the grounding wire to either flat-head terminal.

Check with a qualified electrician or serviceman if the grounding wire instructions are not completely understood, or if in doubt as to whether the product is properly grounded.

This product is factory equipped with a specific electric cord and plug to permit connection to a proper electric circuit. Make sure that the product is connected to an outlet having the same configuration as the plug.

No adapter should be used with this product. Do not modify the plug provided - if it will not fit in the outlet, have the proper outlet installed by a qualified electrician.

If the product must be reconnected for use on a different type of electric circuit, the reconnection should be made by qualified service personnel.

If it is necessary to use an extension cord, use only a three wire extension cord that has a three blade grounding plug, and a three-slot receptacle outlet that will accept the plug on the product.

Replace or repair a damaged cord.

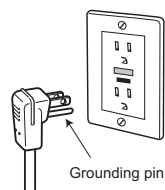

Save these instructions.

Operational Precautions

■ For prevention of malfunctions

- Do not block the body sensor or the remote control transmitter or receiver.

<About the Body Sensors>

Two types of body sensor are used.

- **Body sensor A detects changes in heat.**
 - Detection may be difficult when the room temperature exceeds 86 °F (30 °C), such as in the summertime.
 - When sunlight is directly on the sensor area or a heater is used in the bathroom, the sensor may detect incorrectly due to the heat, resulting in the automatic operation of functions such as auto lid opening and closing.
 - When the bathroom door is open, the sensor may detect people who pass to the front or side of the toilet.
 - **Body sensor B detects when someone stands in front of the toilet bowl.**
 - Body sensor B emits an infrared beam as shown in the figure. When someone moves into the line of this infrared beam, the sensor detects the person.
- * Detection by the sensor may be difficult when the toilet is used by someone small, such as a child.



<About the seat switch>

- **When you sit on the toilet seat, the seat switch turns ON, enabling you to use various features.** (A click sound is heard when the seat switch is ACTIVATED.)
-
- **The seat switch will not turn on unless you sit on the seat properly.**



Note

- When a child uses the Washlet, the seat switch may not be ACTIVATED their light body weight.
- Since the toilet seat is designed to move up and down, a clearance is provided between the toilet seat cushion and the toilet bowl.

■ For prevention of damage

- Wipe plastic areas such as the main unit and remote control with a soft, wet cloth.

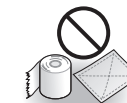

- Do not lean against the toilet lid.

■ Problem Prevention

[USA]

- Disconnect the power plug if there is a risk of lightning.

[Asia, Oceania]

- Switch the breaker on the distribution board to OFF if there is a risk of lightning.
- A toilet seat cover or a toilet lid cover cannot be used. (The body sensor or seat switch may not function properly.)



- Do not urinate on the main unit, toilet seat or wand. (Doing so may cause pink or brown stains or a malfunction.)
- Do not apply strong forces to the control panel of the remote control.
- When using a toilet bowl cleaner to clean the toilet, wash it off within 3 minutes and leave the toilet seat and toilet lid open.
 - Wipe off any cleaner that remains on the toilet bowl. (If vapor from a toilet bowl cleaner enters the main unit, it may cause a malfunction.)
- Do not expose to direct sunlight. (Doing so may cause temperature changes resulting in changes in color, irregular heated seat temperature, a remote control malfunction, or a Washlet malfunction.)
- Use radios, etc. away from the Washlet. (The Washlet could cause interference with the radio signal.)
- If you use a booster seat for infants or a soft highchair, remove it after use. (Keeping it installed may prevent some of the functions from being used.)
- Do not apply force to the remote control. (May cause malfunctions.) To prevent the hanger from being dropped, set it in the remote control hanger when you are not using it. Be careful not to expose it to water.

About rear cleansing, soft rear cleansing, front cleansing and wide front cleansing

- These functions wash away waste and dirt from a localized area of your body.
- Do not cleanse too much or for too long.
- Doing so may wash away normal bacteria, upsetting the balance of bacteria inside your body.
- People who are receiving medical treatment or therapy in this localized area should consult their doctor before use.

Parts Names

S350e
S300e

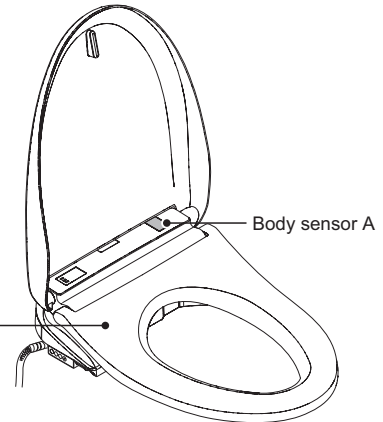
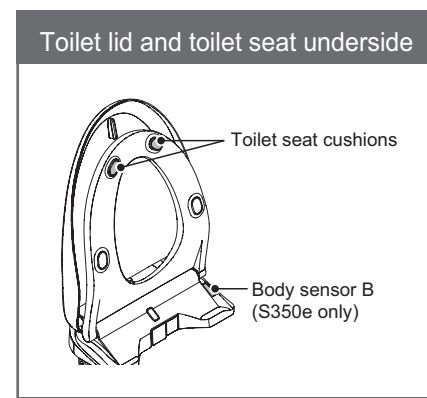
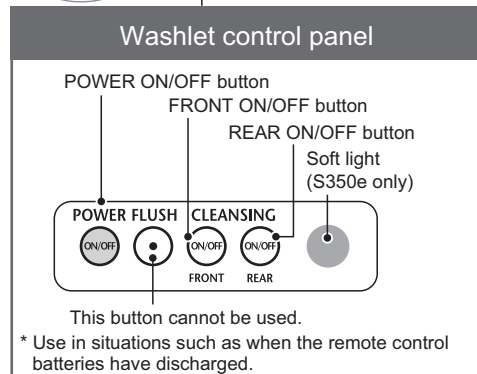
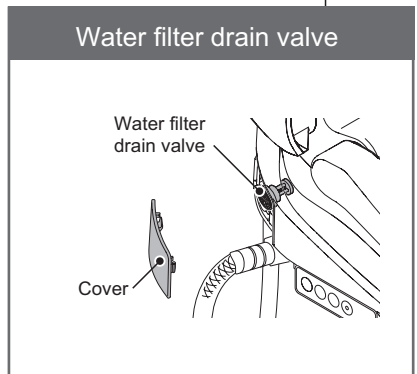
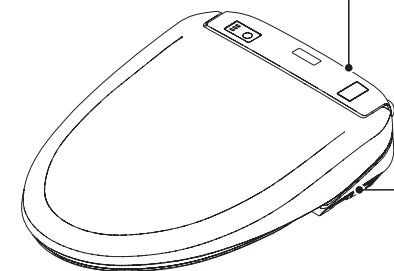
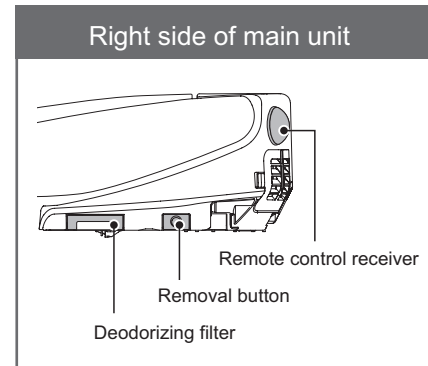
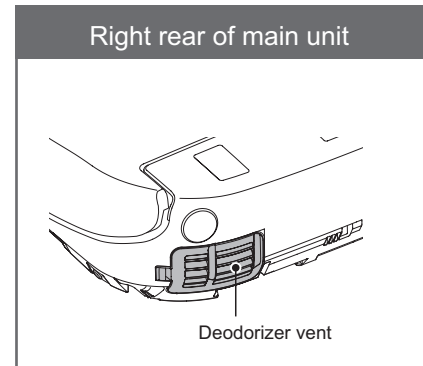
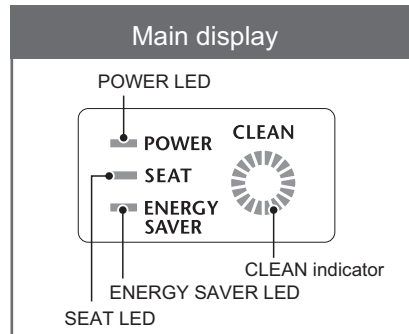
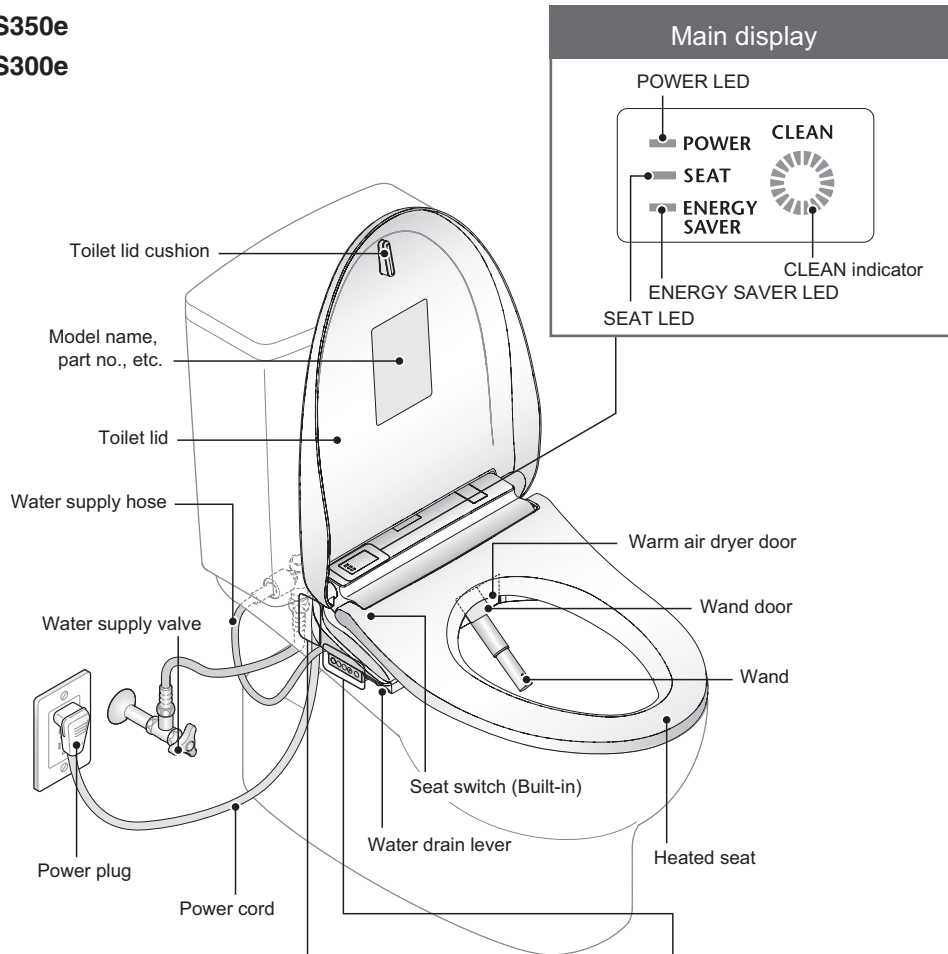

Parts Names

TCF4732A
TCF4731A

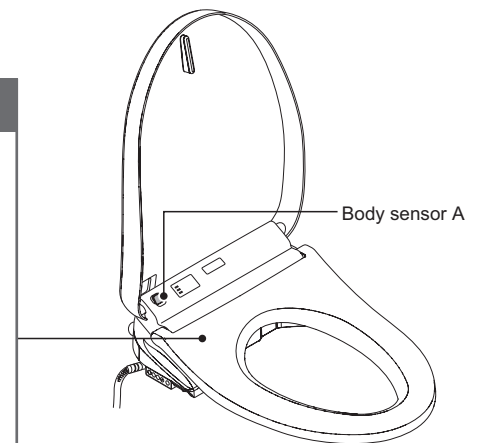
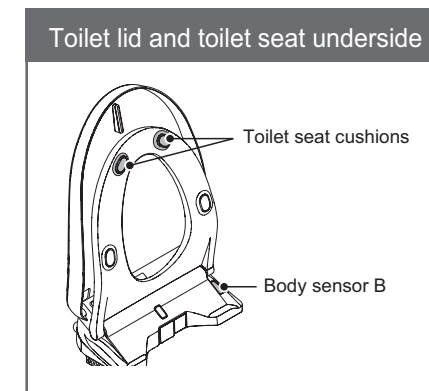
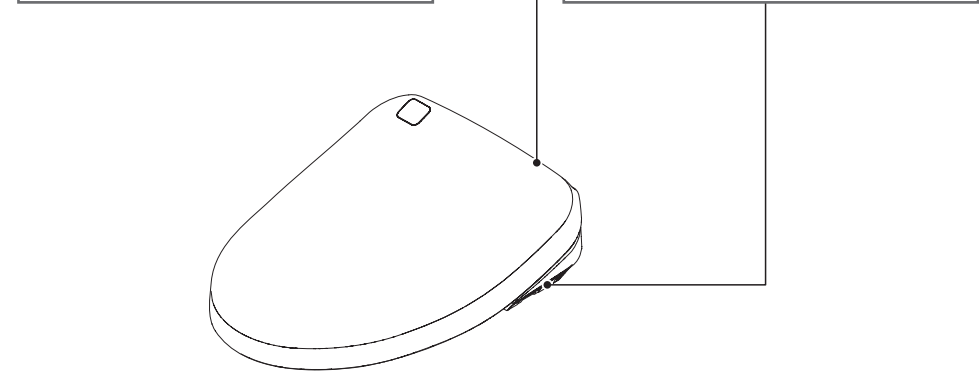
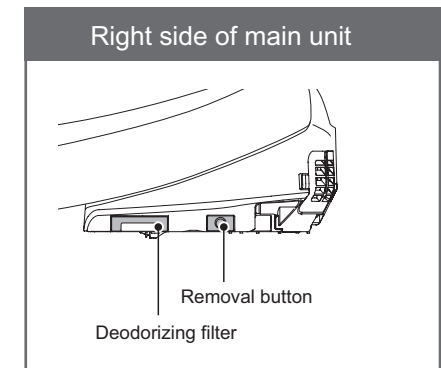
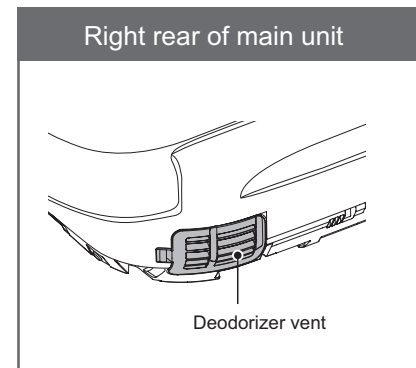
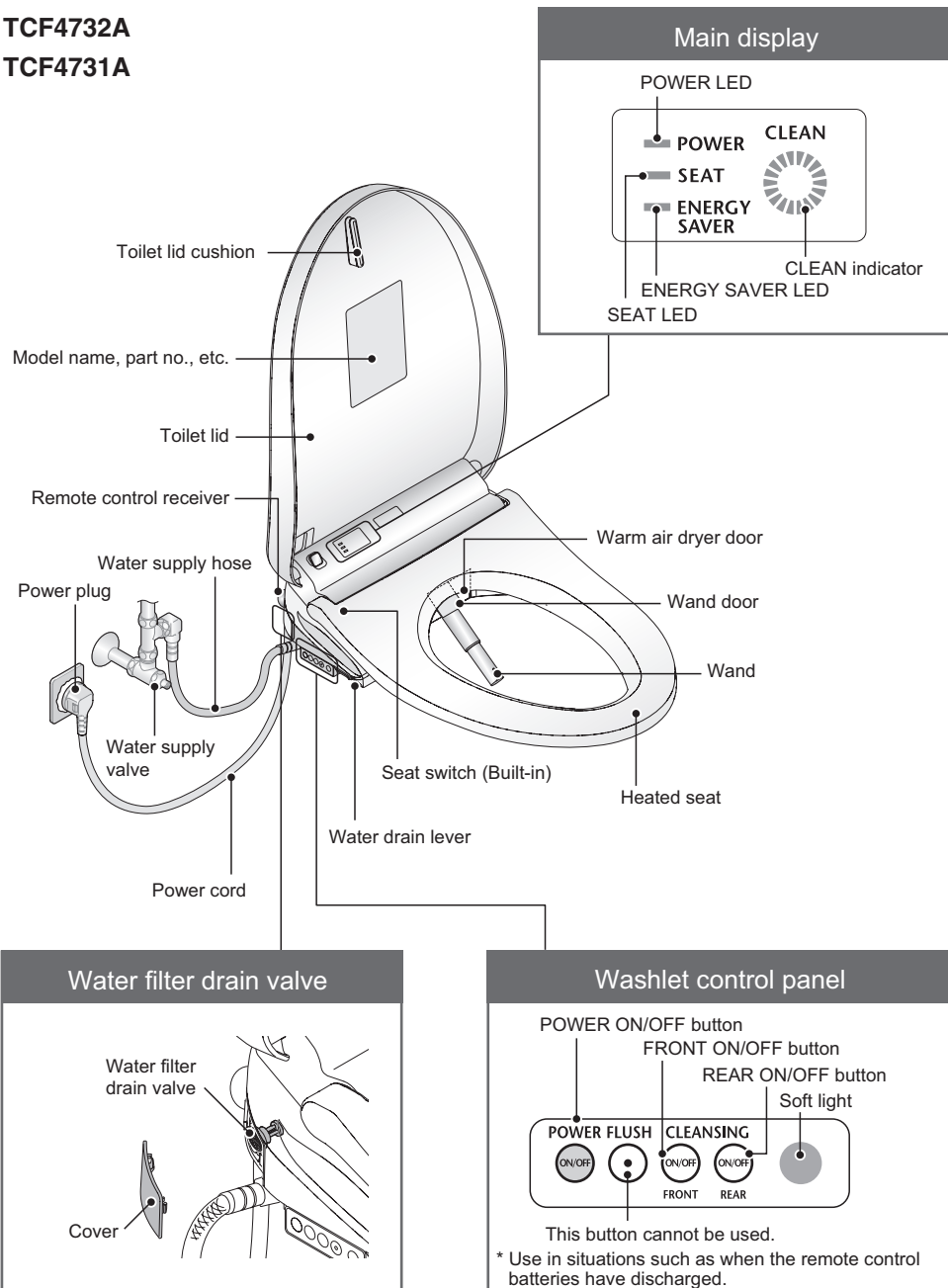

Preparation Using the Washlet for the First Time

1. Insert the battery.

- 1 Remove the remote control from the hanger.

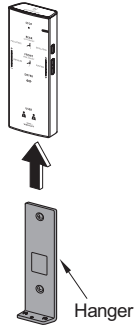

When the remote control is locked to prevent theft

- 1 Remove the screw from the remote control fixture.

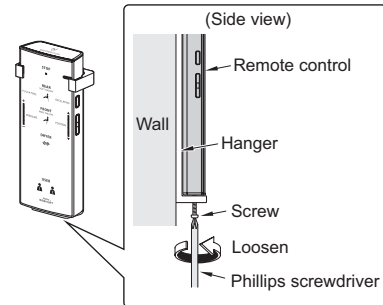

- 2 Remove the remote control from the hanger.

- To return
- Tighten the screw. (Overtightening may cause damage to parts such as the hanger.)

- 2 Open the battery cover and insert two AA batteries.

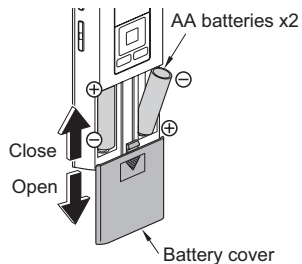

- 3 Mount the remote control in the hanger.

■ About the batteries

- Use dry cell, alkaline batteries. Follow the instructions below to prevent the batteries from rupturing or leaking fluid.
- When replacing the batteries, use new batteries of the same brand.
- If you will not be using the remote control for a long time, remove the batteries.
- Do not use rechargeable batteries.

2. Turn on the power.

- 1 [USA]
Insert the power plug.

- The wand extends and then retracts.

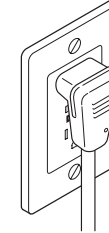

[Asia, Oceania]

Switch the breaker on the distribution board to ON.

- The wand extends and then retracts.

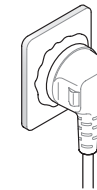

- 2 Check that the POWER LED on the main display is lit up.

- If the LED is not lit up, pressing [POWER ON/OFF] will light it up.
- If the POWER lamp flickers, the main unit is not installed properly. Mount the main unit again. (Page 34)

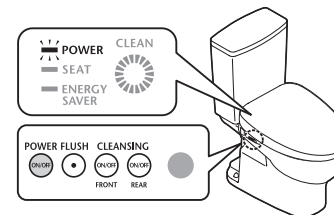

3. Open the water supply valve.

- 1 Fully open the water supply valve.

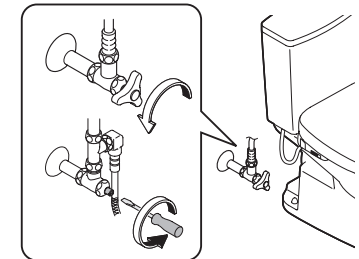

Basic Operations

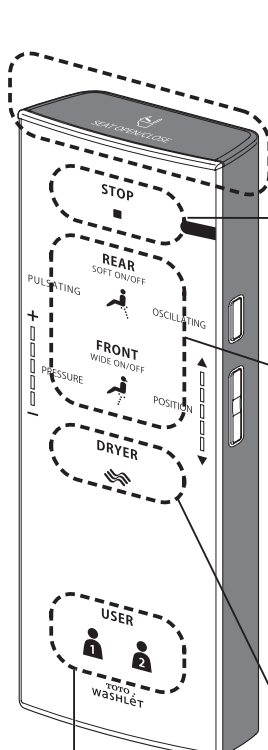

Opening and closing

[SEAT OPEN/CLOSE]
Opens and closes the toilet seat.
(S350e, TCF4732A, TCF4731A only)

Stopping

[STOP]
Stops the operation.

Cleansing

[SOFT REAR]
Cleanses your rear with mild water pressure.

* The mode changes between [SOFT REAR] (Flickering) and [REAR] (Lit) each time the button is pressed.

[REAR]
Cleanses your rear.

* The mode changes between [FRONT] (Flickering) and [WIDE FRONT] (Lit) each time the button is pressed.

[FRONT]
Serves as a bidet for women.

[WIDE FRONT]
Serves as a bidet over a wider area.

Drying

[DRYER]
Dries your front and/or rear.



[PERSONAL SETTING LOCK 1/PERSONAL SETTING LOCK 2]
You can store your preferred wand position, water pressure and warm water temperature settings.

- To store a setting
While cleansing is in progress, set your preferred wand position, water pressure and warm water temperature, and then press and hold "1" or "2" for 2 seconds or longer.
- To use
After "1" or "2" is pressed, please push the button used for cleaning.
*The wand position and water pressure LED's will light up for about 10 seconds displaying the programmed personal settings. Then the water temperature display will also show the programmed personal setting.

● Functions that operate when a button is pressed during "REAR", "SOFT REAR", "FRONT" or "WIDE FRONT" cleansing.

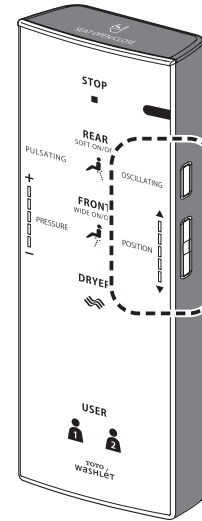

[OSCILLATING]

The wand moves back and forth to wash your rear thoroughly. The setting changes between "ON" and "OFF" each time the button is pressed. You can use this function whenever you feel like it.

[POSITION]

The wand position can be adjusted to the front or rear.
"▲" Moves to the front, "▼" Moves to the rear)

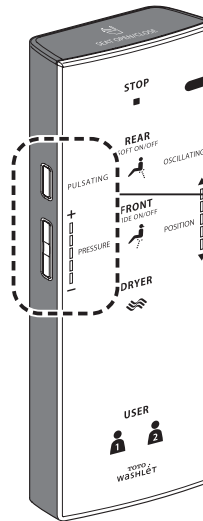

[PULSATING]

Washes with the water pressure pulsating between soft and strong. The setting changes between "ON" and "OFF" each time the button is pressed. You can use this function whenever you feel like it.

[PRESSURE]

The water pressure strength can be adjusted for cleansing functions such as REAR.
("+": Stronger, "-": Softer)

Basic Operations About the Menu Screen

This section is an overview of the settings that can be configured with the remote control.

- See the corresponding pages for the detailed descriptions.
- The setting features vary according to the model.

Remote control backside

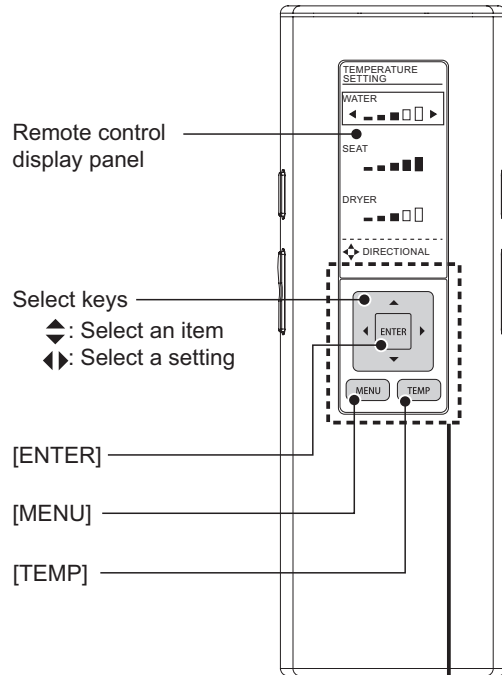

Press [MENU] to display the menu screen.

Setting lock

You can lock the settings so that you do not mistakenly operate the back buttons while using the remote control.

How to set (Page 48)

Display screen during setting lock

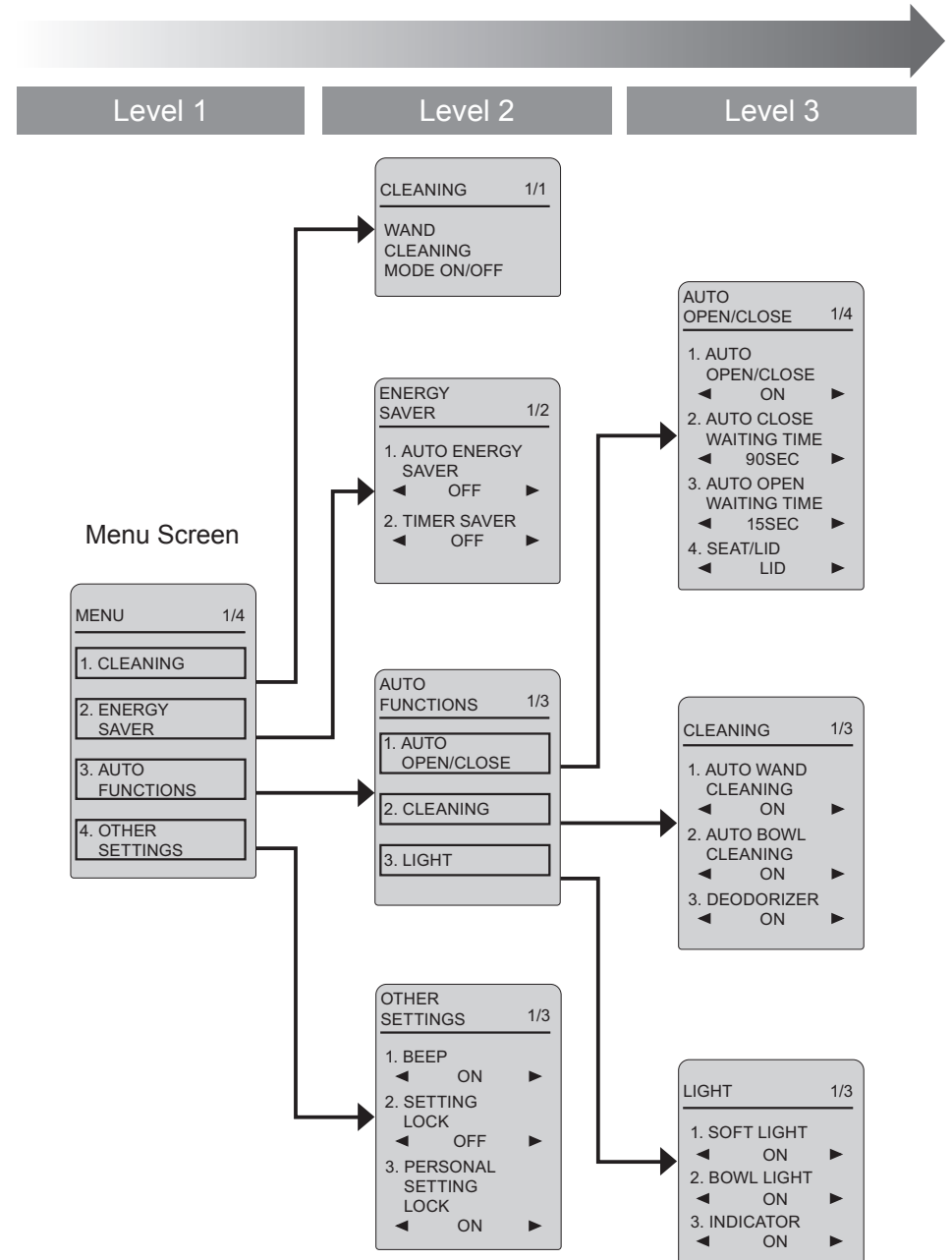

Operation

Automatic Functions Convenience Features

Various automatic functions are available, such as a toilet lid that opens and closes automatically.

• Operation under the initial settings is described below.

Approaching



Sitting



Standing up



Moving away



Note

Changing settings

Opening the toilet lid automatically AUTO OPEN/ CLOSE *

When using the toilet seat



Toilet lid opens



Toilet lid closes
(About 90 seconds after standing up from the toilet seat.)

When standing up to urinate



Toilet lid opens
* Open the toilet seat with the remote control.



Toilet lid closes
(About 90 seconds after moving away by about 0.98 ft (30 cm) or more.)

- When the room temperature reaches about 86 °F (30 °C) or higher, the sensor may not detect properly. (Open and close manually.)
- When the toilet lid is closed with the remote control or by hand, it cannot open automatically for about 15 seconds. (Open and close manually.)
- If you sit on the toilet seat or standing in front of the toilet bowl briefly, it will take about 5 minutes to close automatically.

- Auto setting ON/OFF
- Time until closing (→ Page 40)
- Time until opening
- Automatically opening, both the toilet seat and toilet lid instead of just the lid. (→ Page 42)

Lighting up the inside of the bathroom with a soft light SOFT LIGHT *

Middle mode lights up



High mode lights up



Middle mode lights up (About 90 seconds after standing up.)



Low mode lights up (Goes out after about 5 seconds.)



- Soft light ON/OFF (→ Page 46)

* Cannot be used for S300e.

Automatic Functions Cleansing Features

"ewater+"* is used automatically to clean the wand and toilet bowl.

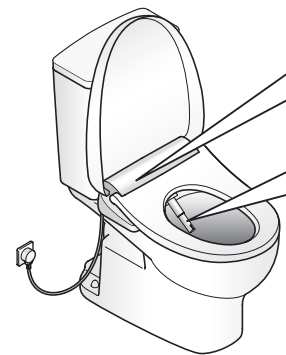
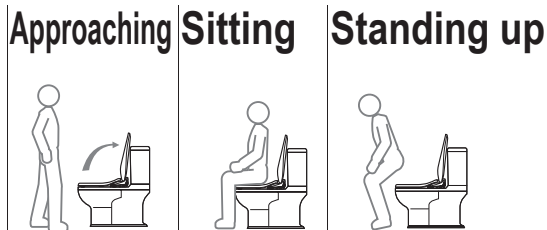

Supports cleaning.

■ **INDICATOR**

Lights to show that the "clean" functions are operating.



■ **BOWL LIGHT**

Lights to show that auto bowl cleaning and auto wand cleaning are operating.

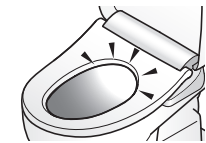

■ **Note**

■ **Changing settings**

<p>DEODORIZER</p>	<p>Starts the deodorizer</p>	<p>Deodorizer stops (After about 2 minutes)</p>	<ul style="list-style-type: none"> • DEODORIZER ON/OFF (→ Page 44)
<p>Clean the wand automatically with clean and sterile water* AUTO WAND CLEANING</p>		<p>Cleans the wand automatically (After about 25 seconds, the wand extends and "ewater+"* comes out from the base of the wand.) (Only when the cleansing functions are used.)</p>	<ul style="list-style-type: none"> • When the wand has not been cleaned in 8 hours, the wand is cleaned automatically. (Water comes out near the wand cover.) • AUTO WAND CLEANING ON/OFF (→ Page 44)
<p>Sanitize the toilet bowl with "ewater+"* AUTO BOWL CLEANING</p>	<p>Pre-mist (A mist is sprayed inside the toilet bowl to make it more difficult for dirt to adhere.)</p>	<p>After-mist (After the automatic wand cleaning is finished, "ewater+"* mist is sprayed inside the toilet bowl.)</p>	<ul style="list-style-type: none"> • The pre-mist and after-mist are not sprayed if the toilet seat is open. • The pre-mist is not sprayed for about 90 seconds after the after-mist has finished. • When the bowl has not been cleaned in 8 hours, the mist is sprayed inside the toilet bowl automatically. • AUTO BOWL CLEANING ON/OFF (→ Page 44)
<p>BOWL LIGHT</p>	<p>LED inside the toilet bowl lights up during pre-mist</p>	<p>LED inside the toilet bowl lights up during the auto wand cleaning and after-mist</p>	<ul style="list-style-type: none"> • BOWL LIGHT ON/OFF (→ Page 46)
<p>INDICATOR</p>	<p>CLEAN indicator lights up</p>	<p>CLEAN indicator lights up cyclically</p>	<ul style="list-style-type: none"> • Lights up when "Auto wand cleansing", "Auto bowl cleaning" or "Deodorizing" is operating. (Only when sitting on the toilet seat.) • INDICATOR ON/OFF (→ Page 46)

If dirt adheres...

■ **If dirt adheres to the wand during use, you can extend the wand to clean it.**

- Cleaning the wand (Page 36)

* **What is meant by "ewater+" ?**



This is a hypochlorous water that is generated from chloride ions in tap water via electrolysis (aka: electrolysed water or EO). It is widely used for cleaning and disinfecting items such as food, utensils and baby bottles.

- Well water may not deliver the required effect. (Because the level of chloride ions is low.)
- Clean, sterile water helps to minimize dirty surfaces, but does not make cleaning unnecessary.
- The effect and duration vary depending on the usage environment and conditions.

Temperature Adjustment Warm Water/Toilet Seat/Drying

1  Press [TEMP].

2  Use  to select the temperature you want to set.



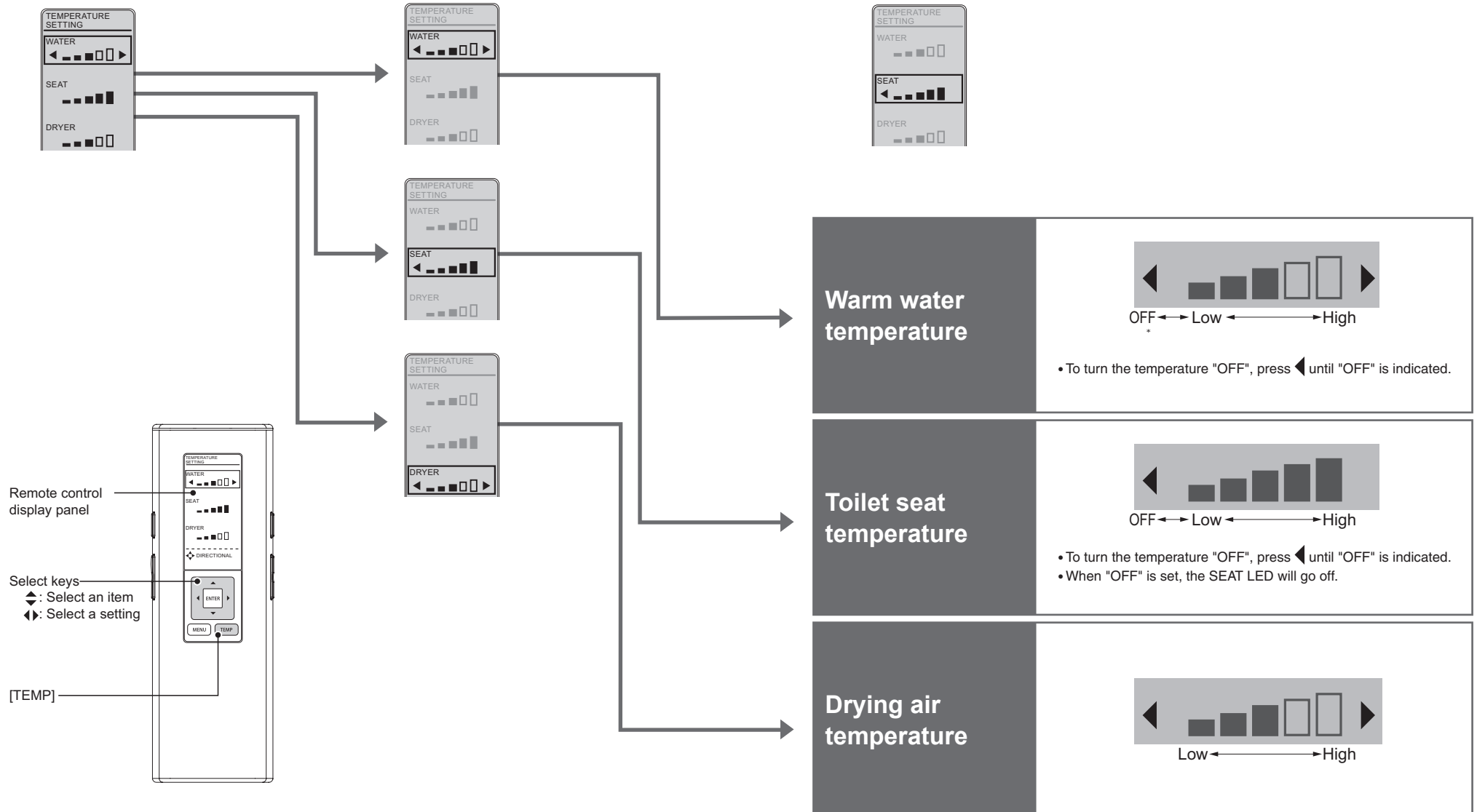

3  Use  to select the temperature level.

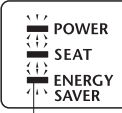
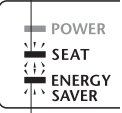

* To prevent condensation, the warm water temperature does not drop below 68 °F (20 °C) even when set to "OFF".

Energy-Saver Features Type

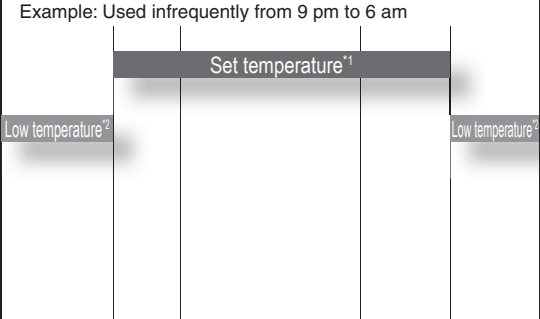
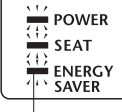
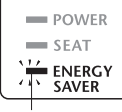
You can save energy by turning the toilet seat heater to a low temperature (or turning the heater "OFF") during periods when the toilet will be used infrequently.

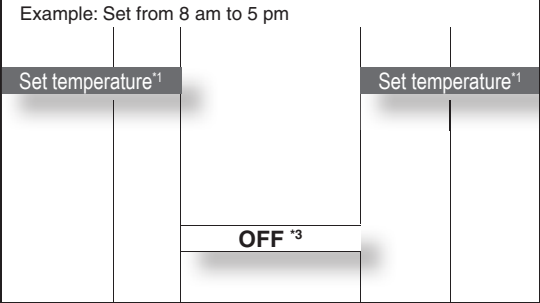
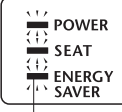
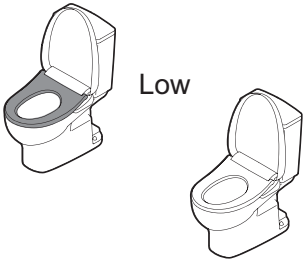
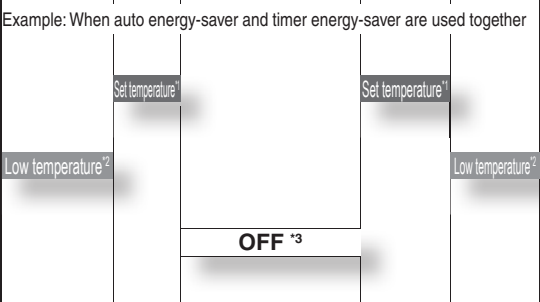
Type	Situation	Energy-Saver Status		Toilet seat heater	AM 0 6 8 PM 5 9 0					
		Main Display			Operation					
Auto energy-saver	<p>You want to save energy but dislike a cold toilet seat</p> <p>The Washlet detects time periods with infrequent use and lowers the toilet seat temperature automatically.</p>	<p>When energy-saver is set...</p>  <p>(Green)</p>	<p>When the energy-saver time arrives...</p>  <p>(Orange)</p>	 <p>Low</p>	<p>Example: Used infrequently from 9 pm to 6 am</p> 					
Timer energy-saver	<p>You want to save energy only at the specified times</p> <p>When the desired time for saving energy is set, the heater is turned off automatically every day at this time.</p>	<p>When energy-saver is set...</p>  <p>(Green)</p>	<p>When the energy-saver time arrives...</p>  <p>(Green)</p>	 <p>OFF</p>	<p>Example: Set from 8 am to 5 pm</p> 					
Auto energy-saver + Timer energy-saver	<p>You want to save a lot of energy with auto energy-saver and timer energy-saver</p> <p>When both auto energy-saver and timer energy-saver are set, auto energy-saver operates when timer energy-saver is not operating.</p>	<p>When energy-saver is set...</p>  <p>(Green)</p>	<p>When the energy-saver time arrives...</p> <ul style="list-style-type: none"> ● During auto energy-saver: Same LED indication as auto energy-saving (see above) ● During timer energy-saver: Same LED indication as timer energy-saver (see above) 	 <p>Low OFF</p>	<p>Example: When auto energy-saver and timer energy-saver are used together</p> 					

Note

- Even if the toilet seat heater is set to "Low" or "OFF", the toilet seat is temporarily heated when you sit on it.
- Auto energy-saver takes about 10 days to detect time periods in which the toilet seat is never or infrequently used.



*1 The toilet seat temperature set on page 26.

*2 The time period when the toilet seat heater is set to a low temperature by auto energy-saver.

*3 The time period when the toilet seat heater is "OFF".

Energy-Saver Features How to Set

1  Press [MENU].

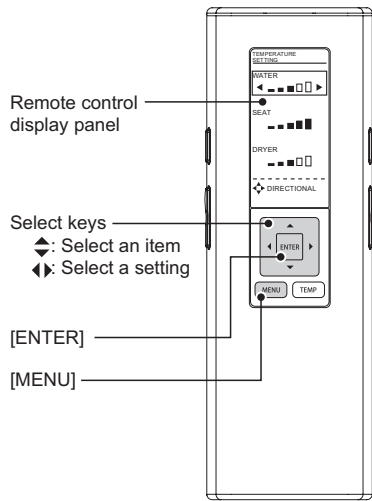

2  Use  to select "ENERGY SAVER" and then press [ENTER].



When energy-saver is set, the ENERGY SAVER LED (green) lights up.



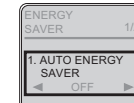

Auto energy-saver

3  Use  to select "AUTO ENERGY SAVER".

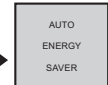

4  Use  to select "ON" and then press [ENTER].



(To return → )



Timer energy-saver

Example: To save energy from 1 am to 7 am (for 6 hours)

Perform the operation at the start time for timer energy-saver (1 am).

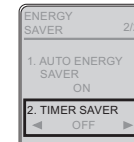
3  Use  to select "TIMER SAVER".



4  Use  to select "3H", "6H", "9H" or "OFF" and then press [ENTER].

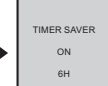
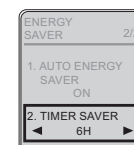

(To return → )

■ To change the energy-saver time or start time → Redo from step **3**.

Turning off energy-saver

Select "OFF" in step **4** above.

Maintenance Power plug

Do not use a dry cloth or toilet paper on plastic parts.

(May cause damage.)

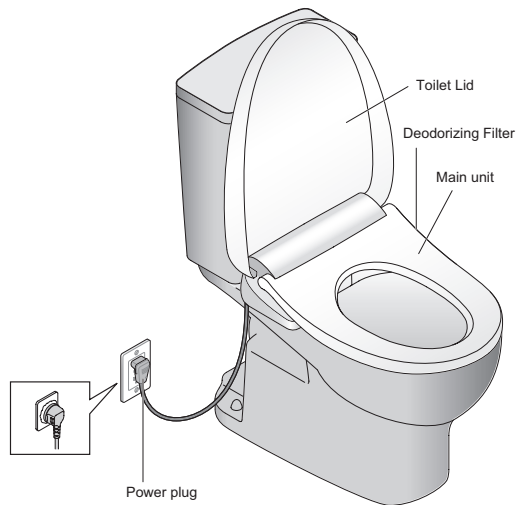
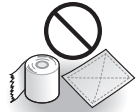

[USA]

For safety, disconnect the power plug before cleaning.

[Asia, Oceania]

Switch OFF the breaker in the distribution board before cleaning or maintenance.

* Except when using "Wand cleaning"

* After the power plug is inserted, the toilet lid does not open automatically for about 10 to 60 seconds. (Because it is preparing for operation. S350e, TCF4732A, TCF4731A only.)

Open and close by hand.

Power Plug (Perform monthly) <USA>



Dry cloth



Wet cloth

- 1 Disconnect the power plug and wipe it with a dry cloth.

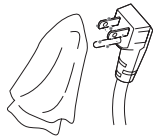

- 2 Insert the power plug.

⚠ WARNING



● Periodically remove dust from the blades and other parts of the power plug.

- Disconnect the plug and wipe it with a dry cloth.



● Fully insert the power plug.

● When disconnecting, hold the main body of the power plug.

- Pulling by the cord may damage the plug or cord.

Main Unit/Deodorizing Filter

Main Unit (Perform monthly)



Wet cloth

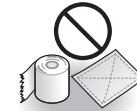

Toilet paper, etc.
(May cause damage.)

- 1 [USA]
Unplug the power plug.
[Asia, Oceania]
Switch the breaker on the distribution board to OFF.

- 2 Wipe with a soft cloth that has been soaked in water and wrung out thoroughly.

■ For heavy dirt

- Wipe with a soft cloth soaked in diluted, neutral kitchen detergent, and then wipe with a soft cloth soaked in water.

- 3 [USA]
Insert the power plug.
[Asia, Oceania]
Switch the breaker on the distribution board to ON.

Attention!

- The Washlet is an electric appliance. Be careful not to allow water to get inside, and not to leave detergent in the gap between the main unit and the toilet bowl.
- Do not push or pull the wand door or the warm air dryer door with undue force. (May cause damage or malfunctions.)

Deodorizing Filter (Perform monthly) <If you notice odors>

- 1 [USA]
Unplug the power plug.
[Asia, Oceania]
Switch the breaker on the distribution board to OFF.

- 2 Remove the deodorizing filter.
 - Hold the knob and pull outward.
 - Do not pull with undue force. (May cause damage or malfunctions.)

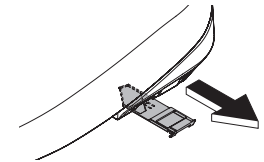

- 3 Clean with a tool such as a toothbrush.
 - When washing with water, dry off all water before mounting.



- 4 Mount the deodorizing filter.
 - Push firmly until a click sound is heard.

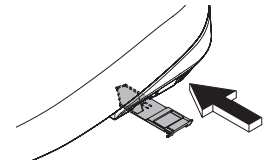

- 5 [USA]
Insert the power plug.
[Asia, Oceania]
Switch the breaker on the distribution board to ON.

Maintenance

Gap between the Main Unit and the Toilet Bowl

Gap between the Main Unit and the Toilet Bowl (Perform monthly)

You can remove the main unit to clean the top of the toilet bowl and the bottom of the main unit.

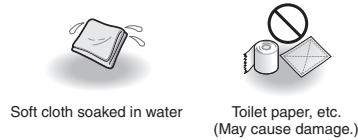

- 1 [USA] Unplug the power plug.
[Asia, Oceania] Switch the breaker on the distribution board to OFF.

- 2 Remove the main unit.
 - Do not pull the unit with undue force (because the water supply hose and power cord are attached).

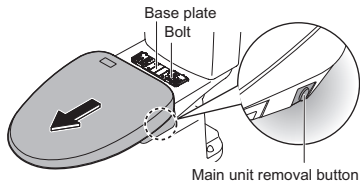

Pull the main unit toward you while pressing the button.

- 3 Clean the gap.
 - Wipe with a soft cloth soaked in a diluted, neutral kitchen detergent, and then wipe with a soft cloth soaked in water so that no detergent remains.

- 4 Mount the main unit.

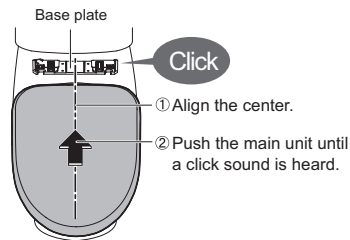

After mounting, check that the main unit does not detach even when pulled.

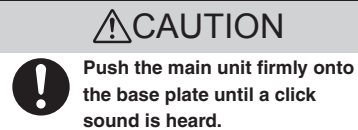

- 5 [USA] Insert the power plug.
[Asia, Oceania] Switch the breaker on the distribution board to ON.

- 6 Check the POWER LED on the Washlet control panel.

POWER LED	Status
Lit	Mounting is OK
Off	Press "Power ON/OFF" and check that it lights up
Flickering	Not mounted properly → Mount again

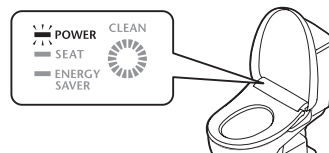

Gap between the Main Unit and the Toilet Lid

Between the main unit and the toilet lid (Perform monthly)

The toilet lid can be removed for thorough cleaning.

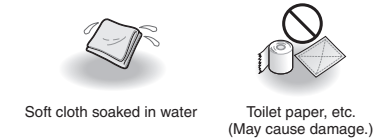

- 1 [USA] Unplug the power plug.
[Asia, Oceania] Switch the breaker on the distribution board to OFF.

- 2 Remove the toilet lid, and then remove the main unit. (Page 34)
 - (A): Pull the left side outward.
 - (B): Disconnect the hinge from the tab and pull up.
 - (C): Disconnect the right side.

- 3 Wipe with a soft cloth that has been soaked in water and wrung out thoroughly.

- 4 Reinstall the toilet lid.
 - (D): Join the pin and the hinge on the right side.
 - Slightly tilt the toilet lid to the front.
 - (A): While pulling out the left side,
 - (E): Mount by joining the hinge with the tab.

* Be careful not to pinch your fingers.

- 5 [USA] Insert the power plug.
[Asia, Oceania] Switch the breaker on the distribution board to ON.

- 6 Open and close the toilet lid to check the mounting, and then mount the main unit.

(Page 34)

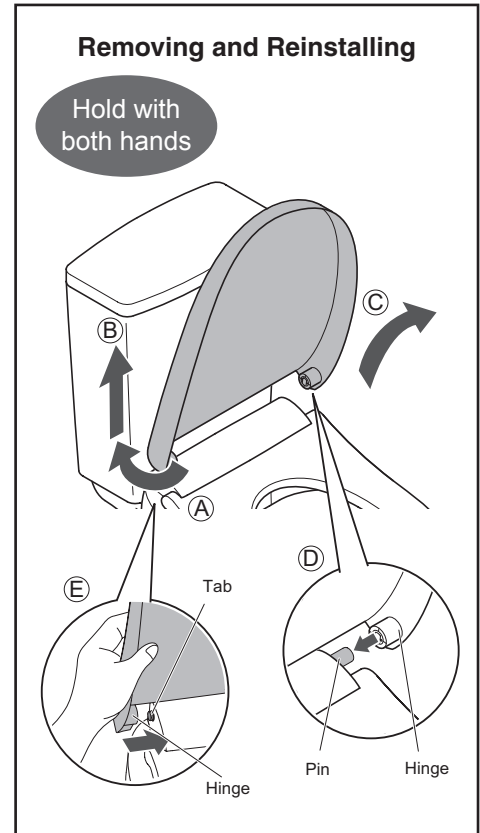

Wand (Perform monthly)

<If you notice dirt>



Soft cloth soaked in water



Toilet paper, etc.
(May cause damage.)

1

Extend the wand.

1. Remove the remote control from the hanger, and press [MENU] on the backside. (Page 16)
2. Use to select "CLEANING" and then press [ENTER].
3. Use to select "WAND CLEANING MODE ON/OFF" and then press [ENTER].
 - The wand extends and water sprays out for cleaning.
 - The wand automatically retracts after about 5 minutes.

2

Wipe with a soft, wet cloth.

- Do not pull, push or press the wand with excessive force.
(May cause damage or malfunctions.)

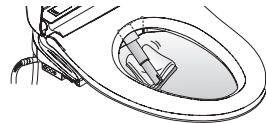

3

Return the wand.

1. In the [WAND CLEANING MODE ON/OFF] screen, press [ENTER] again.
 - The wand retracts.

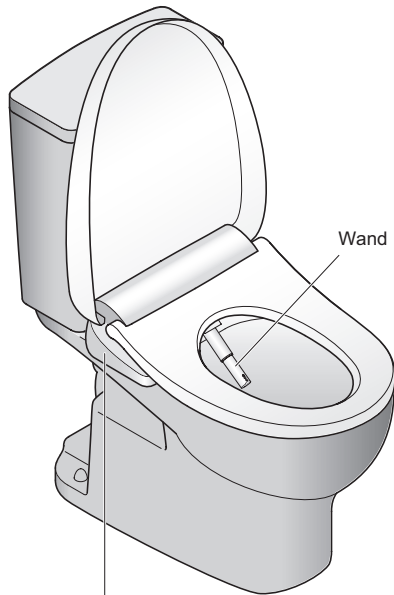
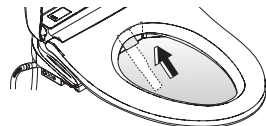

Water filter drain valve

Water Filter Drain Valve (Perform once every 6 months)

<If you think the water pressure has weakened>

CAUTION



Do not remove the water filter drain valve while the water supply valve is open.
(Otherwise, water may leak out.)

1

Close the water supply valve.

(Page 53)

- The water supply stops.

2

Release the pressure from the water supply pipe.

1. Remove the remote control from the hanger, and press [MENU] on the back side. (Page 16)
2. Use to select "CLEANING" and then press [ENTER].
3. Use to select "WAND CLEANING MODE ON/OFF" and then press [ENTER].
 - The wand extends and water comes out.
4. In the [WAND CLEANING MODE ON/OFF] screen, press [ENTER] again.
 - The wand retracts.

3

Remove the cover.

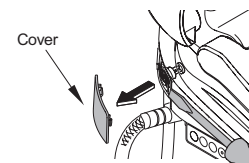

4

[USA] Unplug the power plug.

[Asia, Oceania]
Switch OFF the breaker on the distribution board.

5

Remove the water filter drain valve.

- Loosen the water filter drain valve with a flat-head screwdriver, and then pull on it.

Water filter drain valve

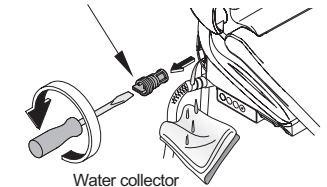

6

Clean with a tool such as a toothbrush.

Also, remove any dust from inside the hole of the drain valve.

7

Mount the water filter drain valve.

- Insert the drain valve and use a flat-head screwdriver to tighten it securely.

8

Mount the cover.

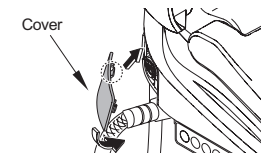

9

[USA] Insert the power plug.

[Asia, Oceania]
Switch ON the breaker on the distribution board.

10

Open the water supply valve.

(Page 17)

Changing Settings Setting List

Various settings can be configured to make the Washlet more convenient and user-friendly for you and your family.

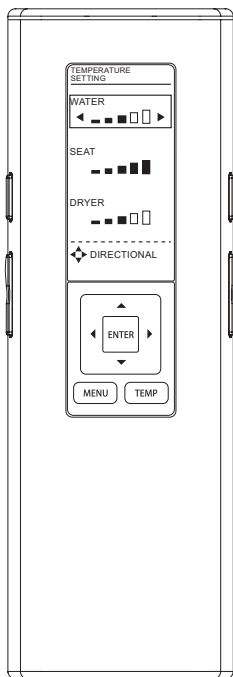

Setting Types		Available Settings*	Applicable Models	Setting Ref. Page		
AUTO FUNCTIONS	AUTO OPEN/CLOSE	AUTO OPEN/CLOSE	• Set whether or not to open the toilet lid automatically	ON/OFF	S350e TCF4732A TCF4731A	Page 40
		AUTO CLOSE WAITING TIME	• Change the amount of time before the lid/seat closes automatically.	90SEC/25SEC		
		AUTO OPEN WAITING TIME	• Change the amount of time before the lid/seat opens automatically after it has been closed manually with the remote control.	15SEC/30SEC/90SEC	Page 42	
		SEAT/LID	• Automatically open and close the toilet lid only/Automatically open and close the toilet seat and toilet lid.	LID/SEAT · LID		
	CLEANING	AUTO WAND CLEANING	• Set whether or not to clean the wand automatically	ON/OFF	All models	Page 44
		AUTO BOWL CLEANING	• Set whether or not to spray mist in the toilet bowl automatically	ON/OFF		
		DEODORIZER	• Set whether or not to deodorize automatically after sitting on the toilet seat	ON/OFF		
	LIGHT	SOFT LIGHT	• Set whether or not to use the soft light	ON/OFF	S350e TCF4732A TCF4731A	Page 46
		BOWL LIGHT	• Set whether or not to use the light inside the toilet bowl	ON/OFF		
INDICATOR		• Set whether or not to light up the CLEAN indicator	ON/OFF	All models		
OTHER SETTINGS	BEEP	• Set whether or not to make a beep sound	ON/OFF	All models	Page 48	
	SETTING LOCK	• Set whether or not to use the setting lock	ON/OFF			
	PERSONAL SETTING LOCK	• Set whether or not to use the personal setting lock	ON/OFF			

* The black text is the initial setting.

Changing Settings

AUTO OPEN/CLOSE

1 Press [MENU].

2 Use to select "AUTO FUNCTIONS" and then press [ENTER].

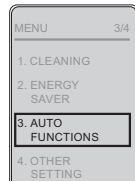

3 Use to select "AUTO OPEN/CLOSE" and then press [ENTER].

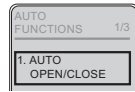

Set whether or not to open the toilet lid automatically

AUTO OPEN/CLOSE

4 Use to select "AUTO OPEN/CLOSE".

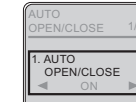

5 Use to select "ON" or "OFF" and then press [ENTER].

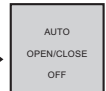
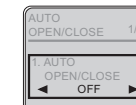

(To return →)

Change the time period till automatic closing

AUTO CLOSE WAITING TIME

4 Use to select "AUTO CLOSE WAITING TIME".

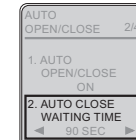

5 Use to select "90SEC" or "25SEC" and then press [ENTER].

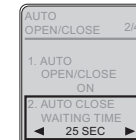

(To return →)

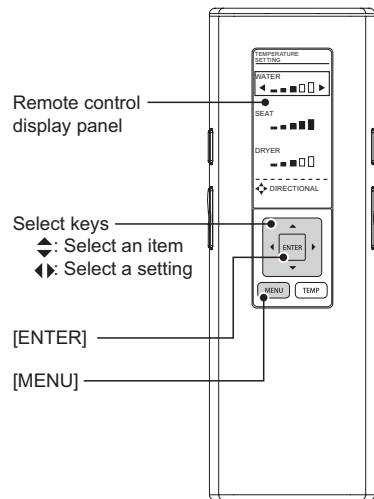

CAUTION

● The setting items and numbers vary according to the model.

Changing Settings

AUTO OPEN/CLOSE

1 Press [MENU].

2 Use to select "AUTO FUNCTIONS" and then press [ENTER].

3 Use to select "AUTO OPEN/CLOSE" and then press [ENTER].

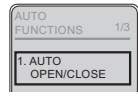
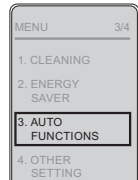

Change the time period till automatic opening (After closing manually.)

AUTO OPEN WAITING TIME

4 Use to select "AUTO OPEN WAITING TIME".



5 Use to select "15SEC", "30SEC" or "90SEC" and then press [ENTER].

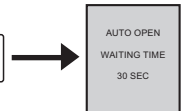

(To return →)

Automatically open and close the toilet lid only/
Automatically open and close the toilet seat and toilet lid

SEAT/LID

4 Use to select "SEAT/LID".



5 Use to select "LID" or "SEAT · LID" and then press [ENTER].

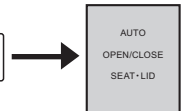

(To return →)

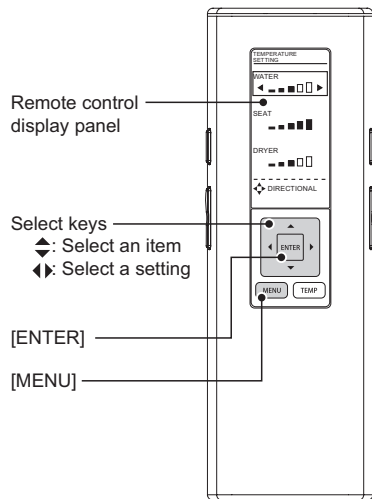



CAUTION



● The setting items and numbers vary according to the model.

Changing Settings

CLEANING

1  Press [MENU].



2  Use  to select "AUTO FUNCTIONS" and then press [ENTER].

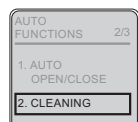
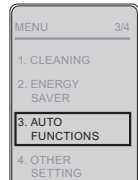

3  Use  to select "CLEANING" and then press [ENTER].



Set whether or not to clean the wand automatically

AUTO WAND CLEANING

4  Use  to select "AUTO WAND CLEANING".



5  Use  to select "ON" or "OFF" and then press [ENTER].





(To return → )

Set whether or not to spray mist in the toilet bowl automatically

AUTO BOWL CLEANING

4  Use  to select "AUTO BOWL CLEANING".

5  Use  to select "ON" or "OFF" and then press [ENTER].





(To return → )

Set whether or not to deodorize automatically after sitting on the toilet seat

DEODORIZER

4  Use  to select "DEODORIZER".

5  Use  to select "ON" or "OFF" and then press [ENTER].

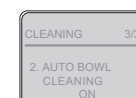
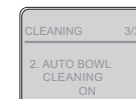

(To return → )

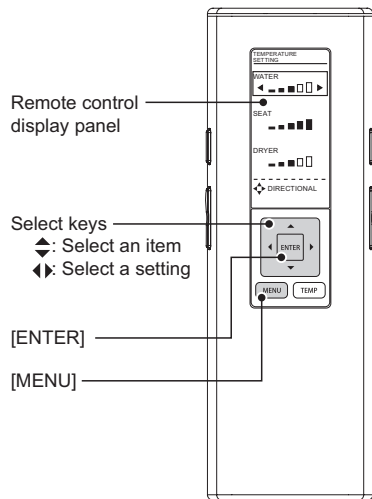

CAUTION

● The setting items and numbers vary according to the model.

Changing Settings

LIGHT

1 Press [MENU].

2 Use to select "AUTO FUNCTIONS" and then press [ENTER].

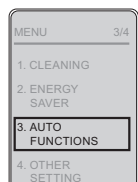

[ENTER]

3 Use to select "LIGHT" and then press [ENTER].



[ENTER]

Set whether or not to use the soft light

SOFT LIGHT

4 Use to select "SOFT LIGHT".



5 Use to select "ON" or "OFF" and then press [ENTER].



[ENTER]



(To return →)

Set whether or not to use the light inside the toilet bowl

BOWL LIGHT

4 Use to select "BOWL LIGHT".

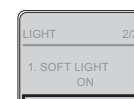

5 Use to select "ON" or "OFF" and then press [ENTER].

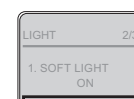

[ENTER]



(To return →)

Set whether or not to light up the CLEAN indicator

INDICATOR

4 Use to select "INDICATOR".

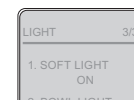

5 Use to select "ON" or "OFF" and then press [ENTER].



[ENTER]

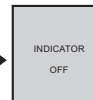

(To return →)

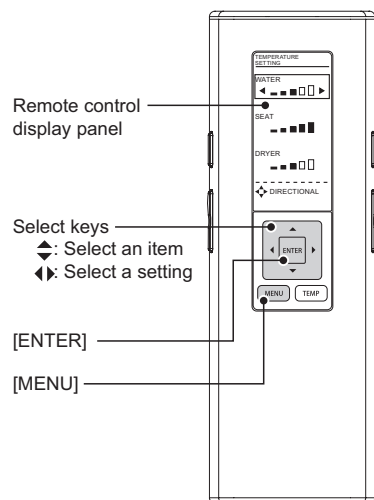



CAUTION

● The setting items and numbers vary according to the model.

Changing Settings

OTHER SETTINGS

1  Press [MENU].

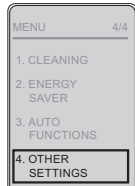

2  Use  to select "OTHER SETTINGS" and then press [ENTER].



Set whether or not to make a beep sound
BEEP



3  Use  to select "BEEP".



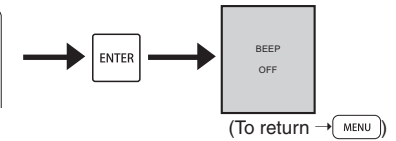
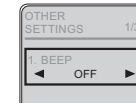

4  Use  to select "ON" or "OFF" and then press [ENTER].

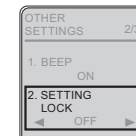

Set whether or not to use the setting lock
SETTING LOCK

3  Use  to select "SETTING LOCK".



4  Use  to select "ON" or "OFF" and then press [ENTER].

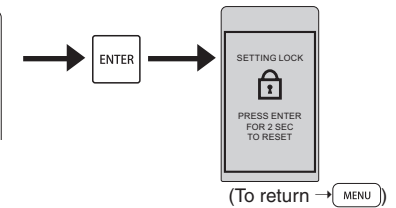
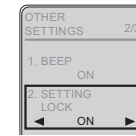

5 Check the displayed screen.





Cancellation method:
Press [ENTER] for 2 seconds or longer.
* If you want to relock after cancellation, reconfigure the setting.

Display screen during setting lock

Set whether or not to use the personal setting lock
PERSONAL SETTING LOCK

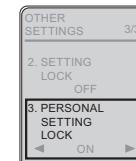
3  Use  to select "PERSONAL SETTING LOCK".



4  Use  to select "ON" or "OFF" and then press [ENTER].

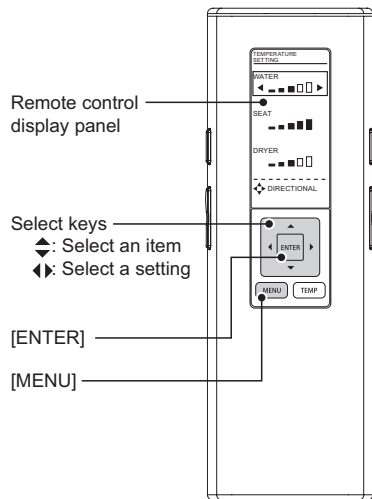
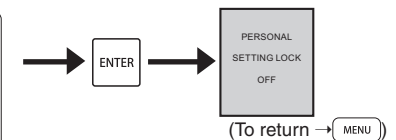
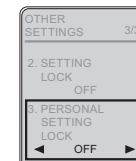

CAUTION

● The setting items and numbers vary according to the model.

What to Do?

If you cannot operate with the remote control

■ Operation is also possible using the buttons on the Washlet control panel.

- The batteries may have worn out. Replace the batteries.

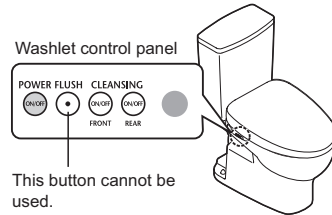

■ Replacing the batteries

- 1 Press **POWER** on the Washlet control panel.
 - The POWER LED goes off.
- 2 Remove the remote control from the hanger. (Page 16)
- 3 Open the cover and replace the AA batteries. (Page 16)
- 4 Mount the remote control in the hanger.
- 5 Press **POWER** on the Washlet control panel.
 - The POWER LED lights up.

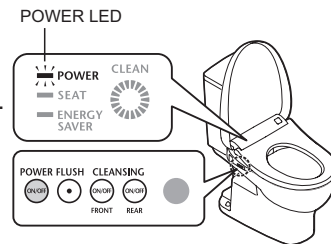

■ About the batteries

- Use dry cell, alkaline batteries. Follow the instructions below to prevent the batteries from rupturing or leaking fluid.
- When replacing the batteries, use new batteries of the same brand.
- If you will not be using the remote control for a long time, remove the batteries.
- Do not use rechargeable batteries.

Freeze Damage Prevention

In preparation for freezing conditions, such as in wintertime, take measures to prevent freezing.

Attention!

- Do not use the energy-saver feature if there is a risk of the product being exposed to freezing temperatures. (The product may be damaged.)
- Warm the bathroom so that the temperature around the product is not below freezing or take other appropriate measures against freezing temperatures.
- Before starting work, set "AUTO OPEN/CLOSE" (S350e, TCF4732A, TCF4731A only) (Page 40) to "OFF".

1 Close the water supply valve.

- The water supply stops.

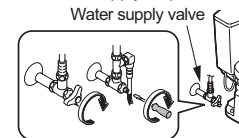

CAUTION

- Do not remove the water filter drain valve while the water supply valve is open. (Otherwise, water may leak out.)

2 Drain the water from the toilet tank.

- Turn the flush handle of the toilet tank to the full flush side.

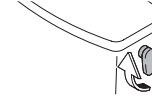

3 Release the pressure from the water supply pipe.

1. Remove the remote control from the hanger, and press [MENU] on the rear side. (Page 16)
2. Use **▲** to select "CLEANING" and then press [ENTER].
3. Use **▲** to select "WAND CLEANING MODE ON/OFF", then press [ENTER]. The wand extends and water comes out.
4. In the [WAND CLEANING MODE ON/OFF] screen, press [ENTER] again. The wand retracts.
5. Remove the cover.



6. Remove the water filter drain valve.

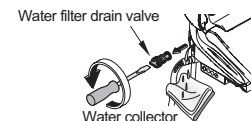

7. Drain the water from the water supply hose.

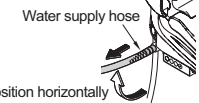

8. After draining the water, mount the water filter drain valve.
 - Tighten it securely using a flat-head screwdriver.

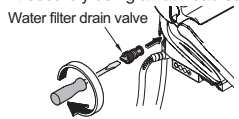

9. Mount the cover.

- 4 Check that the POWER LED on the Washlet main display has lit up. (Page 17)

- 5 Set the toilet seat temperature to "High". (Page 26) (To maintain the temperature, close the toilet seat and toilet lid after finishing work.)

■ When you use Washlet again, the water supply and power supply will be required. (See below)

Resupplying the Water (After draining)

- 1 Open the water supply valve to supply water.
 - Check that there are no leaks in the plumbing or the Washlet.
- 2 Insert the power plug.
 - [USA]
 - [Asia, Oceania]
- 3 Discharge water from the wand.
 1. While pressing the left side of the toilet seat,
 2. Press the "REAR" button on the remote control to discharge water from the wand. (Catch the water in a paper cup or other recipient.)

■ If the remaining water has frozen and no water comes out

- Heat the inside of the bathroom, and warm the water supply hose and water supply valve using a cloth soaked in warm water.

What to Do? Long Periods of Disuse

If you will be absent from home for a long time in the winter, be sure to drain the water to prevent freezing.

Also, if the toilet is in a location you will not visit for a long time, drain the water.

(The water in the tank may become contaminated and cause skin inflammation or other problems.)

How to drain the water

1 Drain the water from the toilet tank.
(Page 51 Steps **1** **2**)

2 Drain the pipe.
(Page 51 Step **3**)

[USA]

- Do not disconnect the power plug until all the water has drained.

[Asia, Oceania]

- Do not switch the breaker on the distribution board to OFF until all the water has drained.

3 Pull out the water drain lever.

- The water comes out from near the wand (about 20 seconds).

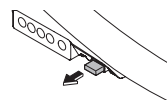

4 Release your hand to return the water drain lever to its original position.

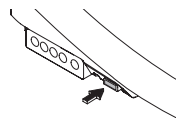

5 [USA] Unplug the power plug.

[Asia, Oceania] Switch the breaker on the distribution board to OFF.

6 Take appropriate measures for the water remaining in the toilet bowl.

- Putting antifreeze in the water remaining in the toilet bowl will reduce its chance of freezing.

■ When you use Washlet again, the water supply and power supply will be required.
(Page 51)

Troubleshooting

First, try the actions described on pages 53 to 57. If the problem persists, consult with the installer, the seller, or the contact referred on the back cover of this manual.

If the CLEAN indicator no longer lights up...

➔ Consult with the contact referred on the back cover of this manual.

CAUTION



If a water leak occurs, close the water supply valve.

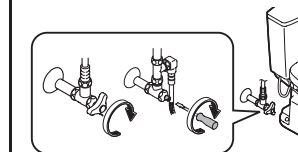

Please check first

Is the POWER LED lit?

■ Does the LED light up when you press [POWER ON/OFF] on the main unit?

■ Is the POWER LED flickering?

- ➔ The main unit is not mounted properly. Mount the main unit again. (Page 34)

■ Is the breaker on the distribution board turned on?

- ➔ Check whether there is a power outage or the breaker has turned "OFF".



Is the ENERGY SAVER LED lit?

■ While the LED is lit, energy-saver (page 28) is in operation, so the toilet seat temperature may be reduced or the heater may be turned off.

Is the remote control working?

■ Are the remote control batteries dead?

- ➔ Replace the batteries. (Pages 16, 50)

■ Is the remote control transmitter or the main unit receiver blocked?

- ➔ Remove obstructions, dirt, water droplets or any other blockages.

The remote control uses batteries to operate.

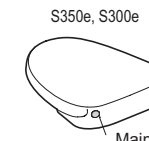
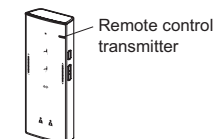
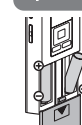

Troubleshooting

Rear and Front Cleansing		
Trouble	Please check	Ref. Page
The wand does not extend.	<ul style="list-style-type: none"> Can you operate with the Washlet control panel? (Check while sitting on the toilet seat.) →Check "Is the remote control working?" 	53
	<ul style="list-style-type: none"> When the temperature is low, it takes time for the wand to come out after the remote control button is pressed because the water must be warmed up first. 	18
	<ul style="list-style-type: none"> Did you sit on the toilet continuously for 2 hours or longer? (If so, operation is stopped for safety purposes.)→Stand up from the seat and then use again. 	–
	<ul style="list-style-type: none"> If the water supply pressure drops significantly, for example if water is used elsewhere or if there is a water failure, the function may stop for safety. [USA] →Disconnect the power plug and wait about 10 seconds before inserting it again. If the same symptom reappears →There may be a malfunction. Consult with the contact referred on the back cover of this manual. [Asia, Oceania] →Switch the breaker on the distribution board to OFF and wait about 10 seconds before inserting it again. If the same symptom reappears →There may be a malfunction. Consult with the contact referred on the back cover of this manual. 	–
	<ul style="list-style-type: none"> The seat sensor may have difficulty detecting some sitting postures. →Sit back on the toilet seat. 	11
	<ul style="list-style-type: none"> Are you using a toilet seat cover, a toilet lid cover, or a seat for infants? →Remove any covers. When using a seat for infants or a soft highchair, remove after each use. 	–
The wand extends but water does not come out./ The cleansing water pressure is weak.	<ul style="list-style-type: none"> Has a water failure occurred? →Press the "STOP" button and wait until the water failure is over. 	–
	<ul style="list-style-type: none"> Is the water supply valve closed? 	17
	<ul style="list-style-type: none"> Is the water filter drain valve clogged with foreign matter? →Clean the filter. 	37
	<ul style="list-style-type: none"> Is the water pressure set to a low level? 	19
The cleansing water is cold.	<ul style="list-style-type: none"> Is the warm water temperature set to "OFF" or a low level? When the temperature of the water supply or the bathroom is low, the water temperature may be low when first sprayed. 	26 –
	<ul style="list-style-type: none"> Rear, soft rear, front, and wide front cleansing stop automatically after 5 minutes of continuous use, while drying stops after 10 minutes of continuous use. Does the seat switch have difficulty detecting? →Sit back on the toilet seat. If you get up slightly from the seat, or sit forward on the seat, the seating switch may temporarily stop detecting your presence. 	– 11
Stops in the middle of use.	<ul style="list-style-type: none"> Has the CLEAN indicator lit up in a cycle? • The wand is cleaned with clean, sterile water. 	24

Warm Air Drying		
Trouble	Please check	Ref. Page
The dryer temperature is low.	<ul style="list-style-type: none"> Is the dryer temperature set to low level? 	26
Stops in the middle of use.	<ul style="list-style-type: none"> Does the seat switch have difficulty detecting? →Sit back on the toilet seat. If you get up slightly from the seat, or sit forward on the seat, the seating switch may temporarily stop detecting your presence. 	11

Toilet Seat and Toilet Lid (AUTO OPEN/CLOSE) For S350e, TCF4732A, TCF4731A only.

Trouble	Please check	Ref. Page
The toilet lid does not open automatically.	<ul style="list-style-type: none"> Is "AUTO OPEN/CLOSE" set to "OFF"? →Set to "ON". Even when set to "ON", AUTO OPEN/CLOSE is not performed for about 15 seconds after the toilet seat or toilet lid is closed. <ul style="list-style-type: none"> When the toilet lid is closed by hand. (To make the Washlet more user-friendly, a time interval is set from when the lid is closed to when it will open next.) Move away from the toilet and wait at least 15 seconds before approaching the toilet bowl again. Detection by the body sensor may be difficult when the room temperature exceeds 86 °F (30 °C). →Open and close by hand. 	40 – 22 –
	<ul style="list-style-type: none"> Is "AUTO OPEN WAITING TIME" set to 30SEC or 90SEC? 	42
	<ul style="list-style-type: none"> [USA] After the power plug is inserted, the toilet lid does not open automatically for about 10 to 60 seconds. →Open and close by hand. [Asia, Oceania] After switching the breaker on the distribution board to ON, the toilet lid does not open automatically for about 10 to 60 seconds. →Open and close by hand. 	–
	<ul style="list-style-type: none"> Is a toilet lid or seat cover installed? →Remove any covers. 	–
The toilet lid does not close automatically.	<ul style="list-style-type: none"> Is "AUTO OPEN/CLOSE" set to "OFF"? →Set to "ON". When the time sitting on or standing in front of the toilet seat is less than 6 seconds, the toilet seat and toilet lid will close after about 5 minutes. If they do not close automatically even though "AUTO OPEN/CLOSE" is set to "ON", the body sensor may be detecting incorrectly. →If there is a reflective object in front, such as a mirror or glass, move the reflective object or use a curtain or other object to block it. 	40 – 11
	<ul style="list-style-type: none"> Is the sensor directly exposed to sunlight? →Do not directly expose the sensor to sunlight, because it may cause incorrect detection. Is there a heater within the detection range of the body sensor? →Do not place within the detection range of the sensor. Is a urinal or wash basin also installed in the bathroom? →The sensor may detect someone using the urinal, causing the toilet lid to open or close. 	11
The toilet lid opens on its own.	<ul style="list-style-type: none"> Is "AUTO OPEN/CLOSE" set to "ON"? Is AUTO CLOSE WAITING TIME set to 25SEC? The seat sensor may have difficulty detecting some sitting postures. →Sit back on the toilet seat. 	40 11

Troubleshooting

Toilet Seat and Toilet Lid (AUTO OPEN/CLOSE) For S350e, TCF4732A, TCF4731A only.

Trouble	Please check	Ref. Page
The toilet lid and toilet seat open at the same time.	<ul style="list-style-type: none"> Are the settings configured to open the toilet lid and toilet seat at the same time? 	42
Stops (or closes) while opening.	<p>[USA]</p> <ul style="list-style-type: none"> If the lid or seat hits an obstruction the first time it opens after inserting the power plug, it may stop (or close) partway during the next operation. <ul style="list-style-type: none"> →While there are no obstructions, disconnect the plug and insert it again after about 5 seconds, and then move out of the toilet room and wait at least 15 seconds before approaching the toilet bowl again. <p>[Asia, Oceania]</p> <ul style="list-style-type: none"> If the lid or seat hits an obstruction the first time it opens after switching ON the breaker on the distribution board, it may stop (or close) partway during the next operation. <ul style="list-style-type: none"> →While there are no obstructions, switch the breaker on the distribution board to OFF and then ON again after about 5 seconds, and then move out of the toilet room and wait at least 15 seconds before approaching the toilet bowl again. 	17
The open timing has changed.	<ul style="list-style-type: none"> Detection by the body sensor may be difficult when the room temperature exceeds 86 °F (30 °C). 	11

Toilet Seat and Toilet Lid

Trouble	Please check	Ref. Page
Cannot open or close with the remote control.	<ul style="list-style-type: none"> If automatic opening works. →Check "Is the remote control working?" 	53
	<ul style="list-style-type: none"> If automatic opening does not work either <ul style="list-style-type: none"> The toilet seat or toilet lid may not be mounted correctly. <ul style="list-style-type: none"> →Mount them correctly. Incorrect detection may occur when operating under fluorescent lights. 	35
The toilet seat does not get warm.	<ul style="list-style-type: none"> Is the toilet seat temperature set to "OFF" or a low level? 	26
	<ul style="list-style-type: none"> Is the ENERGY SAVER LED (green) lit and is the SEAT LED off? <ul style="list-style-type: none"> Timer energy-saver is operating and has turned off the toilet seat heater. <ul style="list-style-type: none"> →When you sit on the seat, the heater is turned on temporarily and the seat is warmed in about 15 minutes. Is the ENERGY SAVER LED (orange) lit? <ul style="list-style-type: none"> If the SEAT LED is lit as well: Auto energy-saver is operating <ul style="list-style-type: none"> →When you sit, the toilet seat is temporarily heated. 	28
	<ul style="list-style-type: none"> Have you been seated for a long time? <ul style="list-style-type: none"> After about 20 minutes of sitting, the temperature starts going down, and after about 1 hour, the heater is turned "OFF". →Move away from the toilet seat and then go back. 	-
	<ul style="list-style-type: none"> The seat sensor may have difficulty detecting some sitting postures. <ul style="list-style-type: none"> →Sit back on the toilet seat. 	11
	<ul style="list-style-type: none"> Is a toilet seat or lid cover installed? →Remove any covers. 	-

Energy-Saver

Trouble	Please check	Ref. Page
The timer energy-saver feature is not working.	<ul style="list-style-type: none"> Did you replace the remote control batteries? <ul style="list-style-type: none"> When the batteries are discharged, the settings may be erased. <ul style="list-style-type: none"> →Reconfigure the settings. 	16 30
The auto energy-saver feature is not working.	<ul style="list-style-type: none"> Because the function takes several days learning the usage conditions before starting energy-saver, the amount of energy saving may be low, depending on the frequency of use. →Check the type of energy saver. 	28

Deodorizer

Trouble	Please check	Ref. Page
The deodorizer is not working.	<ul style="list-style-type: none"> Even after sitting down, you do not hear operation sounds. <ul style="list-style-type: none"> →Sit back on the toilet seat. →Set the deodorizer settings to "ON". If you hear an operation sound when you sit on the toilet seat. <ul style="list-style-type: none"> →Clean the deodorizing filter. 	44 33
A strange odor is emitted.	<ul style="list-style-type: none"> Are you using an air freshener or deodorizer that you purchased separately? <ul style="list-style-type: none"> Doing so may reduce the effectiveness of the Washlet deodorizer or cause strange odors. <ul style="list-style-type: none"> →Remove the air freshener or deodorizer. 	-
The deodorizer is not working.	<ul style="list-style-type: none"> Is "DEODORIZER" set to "OFF"? →Set to "ON". 	44

Sanitary

Trouble	Please check	Ref. Page
The soft light, toilet bowl LED and CLEAN indicator do not light up.	<ul style="list-style-type: none"> Is the setting "OFF"? →Set to "ON". If the CLEAN indicator LED is off, it is time to replace the component that generate a "ewater+-. →Consult with the installer, the seller, or the contact referred on the back cover of this manual. 	46 back cover
The pre-mist sprays out spontaneously.	<ul style="list-style-type: none"> When body sensor A detects someone, the pre-mist is sprayed. When the bowl has not been cleaned in 8 hours, the mist is sprayed inside the toilet bowl automatically. 	25

Others

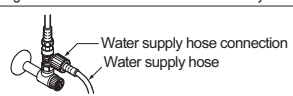
Trouble	Please check	Ref. Page
Water is leaking from the plumbing connections.	<ul style="list-style-type: none"> If any nuts in a connection are loose, firmly tighten them with a tool such as a monkey wrench. <div style="border: 1px solid black; padding: 5px; margin: 10px 0;"> <p>Do not use tools on the water supply hose connection. Tighten it by hand.</p>  </div> <p>→If the water leak does not stop, close the water supply valve and seek repair.</p>	-
The main unit is unstable.	<ul style="list-style-type: none"> There is clearance between the toilet seat cushion and the toilet bowl for activating the seat sensor. When you sit on the toilet seat, the toilet seat subsides slightly to activate the seat sensor. Are the bolts that anchor the main unit loose? <ul style="list-style-type: none"> →Remove the main unit and then firmly tighten the base plate bolts. 	- 34

Specifications **S350e** **S300e**

Item		S350e (S584)	S300e (S574)	S350e (S583)	S300e (S573)	
Rated power supply		AC 120 V, 60 Hz				
Rated power consumption		835 W				
Maximum power consumption		1412 W (When the water supply temperature is 32 °F (0 °C))				
Type		Instantaneous				
Power cord length		3.94 ft (1.2 m)				
Washlet function	Washlet	Spray volume	Rear cleansing	Approx. 0.07 to 0.11 gal/min. (Approx. 0.27 to 0.43 L/min.) <at 29 PSI (0.20 MPa) water pressure>		
			Soft rear cleansing	Approx. 0.08 to 0.11 gal/min. (Approx. 0.32 to 0.43 L/min.) <at 29 PSI (0.20 MPa) water pressure>		
			Front cleansing	Approx. 0.08 to 0.11 gal/min. (Approx. 0.29 to 0.43 L/min.) <at 29 PSI (0.20 MPa) water pressure>		
			Wide front cleansing	Approx. 0.09 to 0.11 gal/min. (Approx. 0.35 to 0.43 L/min.) <at 29 PSI (0.20 MPa) water pressure>		
	Water temperature		Temperature adjustable range: OFF, about 86 to 104 °F (about 30 to 40 °C)			
	Heater capacity		1332 W			
	Safety device		Temperature fuse			
	Backflow prevention device		Vacuum breaker, check valve			
	Dryer		Warm air temperature		Temperature adjustable range: About 95 to 140 °F (About 35 to 60 °C)	
			Airflow volume		10.24 ft ³ /min. (0.29 m ³ /min.)	
			Heater capacity		346.5 W	
			Safety device		Temperature fuse	
	Heated seat		Surface temperature		Temperature adjustable range: OFF, about 82 to 97 °F (about 28 to 36 °C) <In auto energy-saver: About 79 °F (About 26 °C)>	
			Heater capacity		49.5 W	
			Safety device		Temperature fuse	
	Deodorizer		Method		O ₂ deodorizing	
			Airflow volume		Approx. 5.65 ft ³ /min. (Approx. 0.16 m ³ /min.)	
			Power consumption		Approx. 5.3 W	
	Water supply pressure		Minimum required water pressure: 7.25 PSI (0.05 MPa) <Dynamic> Maximum water pressure: 108.75 PSI (0.75 MPa) <Static>			
	Supply water temperature		32 to 95 °F (0 to 35 °C)			
Working ambient temperature		32 to 104 °F (0 to 40 °C)				
Dimensions		W1.28 ft, D1.74 ft, H0.32 ft (W390 mm, D529 mm, H99 mm)		W1.28 ft, D1.57 ft, H0.32 ft (W390 mm, D480 mm, H99 mm)		
Weight		Approx. 11.2 lb (Approx. 5.1 kg)	Approx. 10.1 lb (Approx. 4.6 kg)	Approx. 10.8 lb (Approx. 4.9 kg)	Approx. 9.7 lb (Approx. 4.4 kg)	

* Temperature around the warm air outlet measured by TOTO.

Specifications

Item		TCF4732A	TCF4731A		
Rated power supply		AC 220 V, 50/60 Hz			
Rated power consumption		830 W			
Maximum power consumption		1275 W (When the water supply temperature is 32 °F (0 °C))			
Type		Instantaneous			
Power cord length		3.94 ft (1.2 m)			
Washlet function	Washlet	Spray volume	Rear cleansing	Approx. 0.07 to 0.11 gal/min. (Approx. 0.27 to 0.43 L/min.) <at 29 PSI (0.20 MPa) water pressure>	
			Soft rear cleansing	Approx. 0.08 to 0.11 gal/min. (Approx. 0.32 to 0.43 L/min.) <at 29 PSI (0.20 MPa) water pressure>	
			Front cleansing	Approx. 0.08 to 0.11 gal/min. (Approx. 0.29 to 0.43 L/min.) <at 29 PSI (0.20 MPa) water pressure>	
			Wide front cleansing	Approx. 0.09 to 0.11 gal/min. (Approx. 0.35 to 0.43 L/min.) <at 29 PSI (0.20 MPa) water pressure>	
	Water temperature		Temperature adjustable range: OFF, about 86 to 104 °F (about 30 to 40 °C)		
	Heater capacity		1200 W		
	Safety device		Temperature fuse		
	Backflow prevention device		Vacuum breaker, check valve		
	Dryer		Warm air temperature		Temperature adjustable range: About 95 to 140 °F (About 35 to 60 °C)
			Airflow volume		10.24 ft ³ /min. (0.29 m ³ /min.)
			Heater capacity		237.7 W
			Safety device		Temperature fuse
	Heated seat		Surface temperature		Temperature adjustable range: OFF, about 82 to 97 °F (about 28 to 36 °C) <In auto energy-saver: About 79 °F (About 26 °C)>
			Heater capacity		45.4 W
			Safety device		Temperature fuse
	Deodorizer		Method		O ₂ deodorizing
			Airflow volume		Approx. 5.65 ft ³ /min. (Approx. 0.16 m ³ /min.)
			Power consumption		Approx. 5.3 W
	Water supply pressure		Minimum required water pressure: 7.25 PSI (0.05 MPa) <Dynamic> Maximum water pressure: 108.75 PSI (0.75 MPa) <Static>		
	Supply water temperature		32 to 95 °F (0 to 35 °C)		
Working ambient temperature		32 to 104 °F (0 to 40 °C)			
Dimensions		W1.28 ft, D1.71 ft, H0.43 ft (W390 mm, D520 mm, H130 mm)	W1.28 ft, D1.74 ft, H0.43 ft (W390 mm, D529 mm, H130 mm)		
Weight		Approx. 10.8 lb (Approx. 4.9 kg)	Approx. 10.8 lb (Approx. 4.9 kg)		

* Temperature around the warm air outlet measured by TOTO.

Limited Warranty

S350e,S300e

One Year Limited Warranty

- TOTO warrants its washlet series ("Washlet") to be free from defects in materials and workmanship during normal use when properly installed and serviced, for a period of one (1) year from date of purchase. This limited warranty is extended only to the ORIGINAL PURCHASER of the Washlet and is not transferable to any third party, including but not limited to any subsequent purchaser or owner of the Washlet. This warranty applies only to TOTO Washlet is purchased and installed in North, Central and South America.
- TOTO's obligations under this warranty are limited to repair, replacement or other appropriate adjustment, at TOTO's option, of the Washlet or parts found to be defective in normal use, provided that such Washlet was properly installed, used and serviced in accordance with instructions.
TOTO reserves the right to make such inspections as may be necessary in order to determine the cause of the defect. TOTO will not charge for labor or parts in connection with warranty repairs or replacements. TOTO is not responsible for the cost of removal, return and/or reinstallation of the Washlet.
- This warranty does not apply to the following items:
 - Damage or loss sustained in a natural calamity such as fire, earthquake, flood, thunder, electrical storm, etc.
 - Damage or loss resulting from any accident, unreasonable use, misuse, abuse, negligence, or improper care, cleaning, or maintenance of the Washlet.
 - Damage or loss resulting from sediments or foreign matter contained in a water system.
 - Damage or loss resulting from improper installation or from installation of the Washlet in a harsh and/or hazardous environment, or improper removal, repair or modification of the Washlet. This includes locations where the water pressure is above local codes or standards. (NOTE : Washlet model codes allow a maximum of 80 PSI. Check local codes or standards for requirements).
 - Damage or loss resulting from electrical surges or lightning strikes or other acts which are not the fault of TOTO or which the Washlet is not specified to tolerate.
 - Damage or loss resulting from normal and customary wear and tear, such as gloss reduction, scratching or fading over time due to use, cleaning practices or water or atmospheric conditions.
- If the Danger Label which has been placed over the seams on the back of the Product's top unit is broken or otherwise not intact, this limited warranty is void.
- In order for this limited warranty to be valid, proof of purchase is required. TOTO encourages warranty registration upon purchase to create a record of Product ownership at <http://www.totousa.com>. Product registration is completely voluntary and failure to register will not diminish your limited warranty rights.
- If the Product is used commercially or is installed outside of North, Central or South America, TOTO warrants the Product to be free from defects in materials and workmanship during normal use for one (1) year from the date of installation of the Product, and all other terms of this warranty shall be applicable except the duration of the warranty.
- THIS WARRANTY GIVES YOU SPECIFIC LEGAL RIGHTS. YOU MAY HAVE OTHER RIGHTS WHICH VARY FROM STATE TO STATE, PROVINCE TO PROVINCE OR COUNTRY TO COUNTRY.
- To obtain warranty repair service under this warranty, you must take the Product or deliver it prepaid to a TOTO service facility together with proof of purchase (original sales receipt) and a letter stating the problem, or contact a TOTO distributor or products service contractor, or write directly to TOTO U.S.A., INC., 1155 Southern Road, Morrow, GA 30260 (888) 295 8134 or (678) 466-1300, if outside the U.S.A. If, because of the size of the Product or nature of the defect, the Product cannot be returned to TOTO, receipt by TOTO of written notice of the defect together with proof of purchase (original sales receipt) shall constitute delivery. In such case, TOTO may choose to repair the Product at the purchaser's location or pay to transport the Product to a service facility.

WARNING! TOTO shall not be responsible or liable for any failure of, or damage to, this Product caused by either chloramines in the treatment of public water supply or cleaners containing chlorine (calcium hypochlorite).

NOTE: The use of a high concentrate chlorine or chlorine related product's can seriously damage the fittings. This damage can cause leakage and serious property damage.

THIS WRITTEN WARRANTY IS THE ONLY WARRANTY MADE BY TOTO. REPAIR, REPLACEMENT OR OTHER APPROPRIATE ADJUSTMENT AS PROVIDED UNDER THIS WARRANTY SHALL BE THE EXCLUSIVE REMEDY AVAILABLE TO THE ORIGINAL PURCHASER. TOTO SHALL NOT BE RESPONSIBLE FOR LOSS OF THE PRODUCT OR FOR OTHER INCIDENTAL, SPECIAL OR CONSEQUENTIAL DAMAGES OR EXPENSES INCURRED BY THE ORIGINAL PURCHASER, OR FOR LABOR OR OTHER COSTS DUE TO INSTALLATION OR REMOVAL, OR COSTS OF REPAIRS BY OTHERS, OR FOR ANY OTHER EXPENSE NOT SPECIFICALLY STATED ABOVE. IN NO EVENT WILL TOTO'S RESPONSIBILITY EXCEED THE PURCHASE PRICE OF THE PRODUCT. EXCEPT TO THE EXTENT PROHIBITED BY APPLICABLE LAW, ANY IMPLIED WARRANTIES, INCLUDING THAT OF MERCHANTABILITY OR FITNESS FOR USE OR FOR A PARTICULAR PURPOSE, ARE EXPRESSLY DISCLAIMED. SOME STATES DO NOT ALLOW LIMITATIONS ON HOW LONG AN IMPLIED WARRANTY LASTS, OR THE EXCLUSION OR LIMITATION OF INCIDENTAL OR CONSEQUENTIAL DAMAGES, SO THE ABOVE LIMITATION AND EXCLUSION MAY NOT APPLY TO YOU.

Warranty

TCF4732A,TCF4731A

LIMITED ONE YEAR WARRANTY

- TOTO warrants its products to be free from manufacturing defects under normal use and service for a period of one (1) year from the date of purchase. This warranty is extended only to the ORIGINAL PURCHASER.
- TOTO's obligations under this warranty are limited to repair or replacement, at TOTO's option, of products or parts found to be defective, provided that such products were properly installed and used in accordance with this OWNER'S MANUAL. TOTO reserves the right to make such inspections as may be necessary to determine the cause of the defect. TOTO will not charge for labor or parts in connection with warranty repairs or replacements. **TOTO is not responsible for the cost of removal, return and/or reinstallation of products.**
- This warranty does not apply to the following items:
 - Damage or loss sustained in a natural calamity such as fire, earthquake, flood, thunder, electrical storm, etc.
 - Damage or loss resulting from any unreasonable use, misuse, abuse, negligence, or improper maintenance of the product.
 - Damage or loss resulting from removal, improper repair, or modification of the product.
 - Damage or loss resulting from sediments or foreign matter contained in a water system.
 - Damage or loss resulting from improper installation or from installation of a unit in a harsh and/or hazardous environment.
 - Damage or loss resulting from electrical surges or lightning strikes or other acts which are not the fault of TOTO or which the Washlet is not specified to tolerate.
 - Damage or loss resulting from normal and customary wear and tear, such as gloss reduction, scratching or fading over time due to use, cleaning practices or water or atmospheric conditions.
- This warranty gives you specific legal rights. You may have other rights which vary from country to country.
- To obtain warranty repair service under this warranty, you must take the product or deliver it prepaid to a TOTO service facility, together with a letter stating the problem, or contact a TOTO distributor or product service contractor, or directly to TOTO sales office. If, because of the size of the product or nature of the defect, the product can not be returned to TOTO, receipt by TOTO of written notice of the defect shall constitute delivery. In such case, TOTO may choose to repair the product at the purchaser's location or pay to transport the product to a service facility.

WARNING! TOTO shall not be responsible or liable for any failure of, or damage to, this Product caused by either chloramines in the treatment of public water supply or cleaners containing chlorine (calcium hypochlorite).

NOTE: The use of a high concentrate chlorine or chlorine related product's can seriously damage the fittings. This damage can cause leakage and serious property damage.

THIS WRITTEN WARRANTY IS THE ONLY WARRANTY MADE BY TOTO. REPAIR OR REPLACEMENT AS PROVIDED UNDER THIS WARRANTY SHALL BE THE EXCLUSIVE REMEDY AVAILABLE TO THE PURCHASER. TOTO SHALL NOT BE RESPONSIBLE FOR LOSS OF USE OF THE PRODUCT OR FOR OTHER INCIDENTAL, SPECIAL, OR CONSEQUENTIAL DAMAGE OR EXPENSES INCURRED BY PURCHASER, OR FOR LABOR OR OTHER COSTS DUE TO INSTALLATION OR REMOVAL, OR COSTS OF REPAIRS BY OTHERS, OR FOR ANY OTHER EXPENSE NOT SPECIFICALLY STATED ABOVE. EXCEPT TO THE EXTENT PROHIBITED BY APPLICABLE LAW, ANY IMPLIED WARRANTIES, INCLUDING THAT OF MERCHANTABILITY OR FITNESS FOR USE, ARE EXPRESSLY LIMITED TO THE DURATION OF THIS WARRANTY. SOME STATES DO NOT ALLOW LIMITATIONS ON HOW LONG AN IMPLIED WARRANTY LASTS, OR THE EXCLUSION OR LIMITATION OF INCIDENTAL OR CONSEQUENTIAL DAMAGE, SO THE ABOVE LIMITATION AND EXCLUSION MAY NOT APPLY TO YOU.

MEMO

MEMO