



## Features

- Multi-use handrails can be easily used by physical challenged people in public.
- Exquisite appearance.
- Durable anti-fouling.
- Easy to install and use.

## Specifications

Length : 800 mm.,  $\varnothing$ 34 mm

## Parts description

- T113HK8R  
Flip Up Type Handrail  
without Installation Bolt  
(T110D17S x 1 Pcs.)

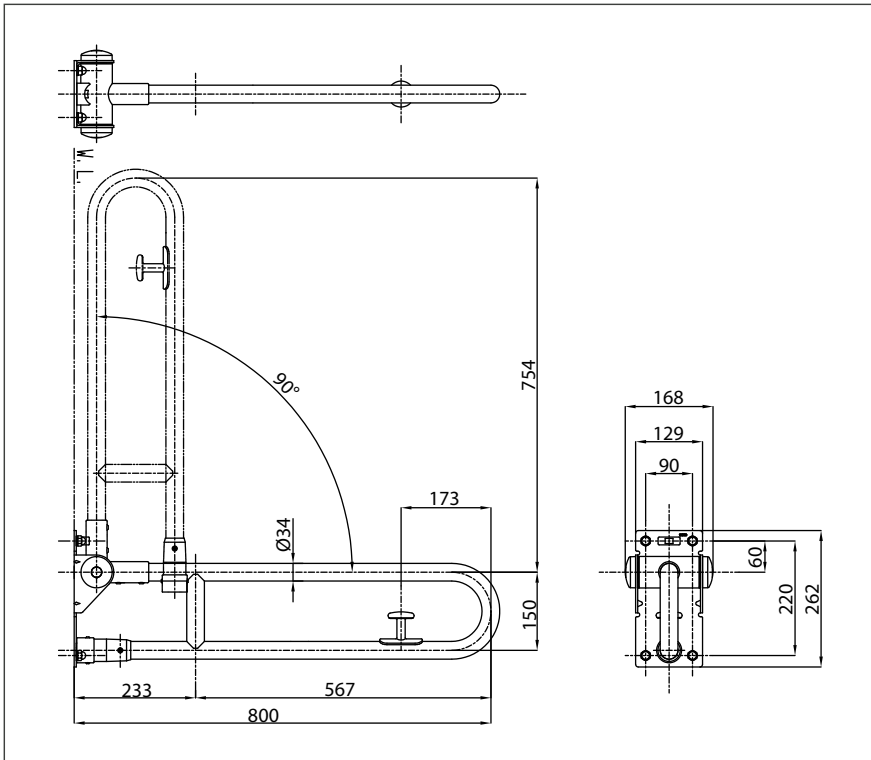

Please consult a TOTO representative for details