



Features

- Multi-use handrails can be easily used by physical challenged people in public.
- Exquisite appearance.
- Durable anti-fouling.
- Easy to install and use.

Specifications

Length : 700 mm., Ø34 mm

Parts description

- T113HK7R
Flip Up Type Handrail
without Installation Bolt
(T110D17S x 1 Pcs.)

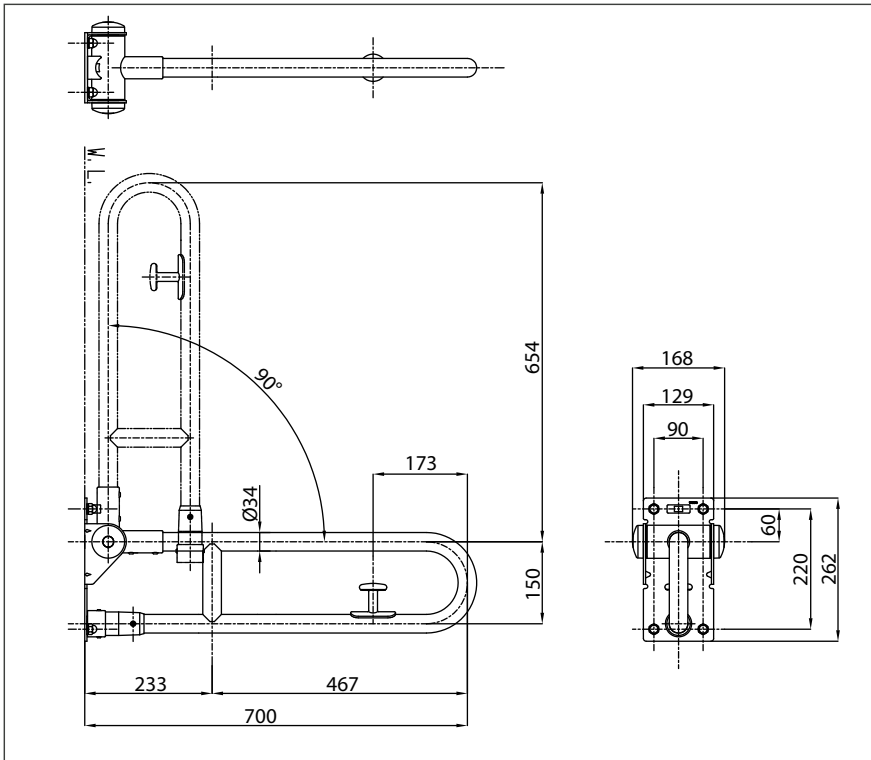

Please consult a TOTO representative for details