

FLOTATION TUB

PJYD2200

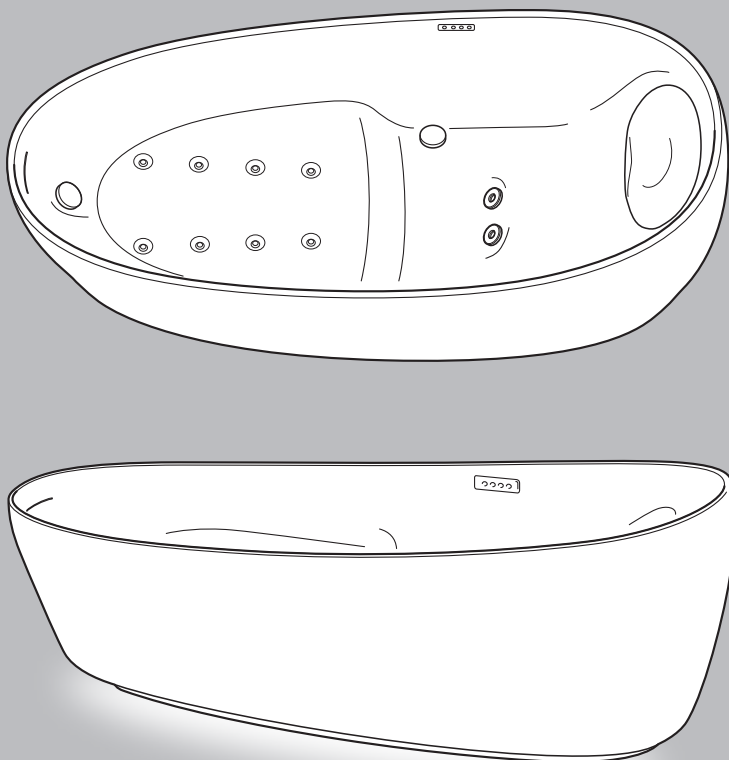

Cautions and warnings	2
Safety precautions	5
Names of parts	6
Before using it for the first time	7

Introduction

How to use	8
• Drain plug	8
• HYDROHANDS and NECK BATH operation	9
• AIR-JET operation	10
• How to use the LED lighting	11
• How to use the key lock	12

How to use

How to maintain	13
• Method of maintenance	13
• Drainage operation for AIR-JET piping	14
• AIR-JET cap	14
• Controller	15
• Head rest	15
• Drain plug	16

Maintenance

Troubleshooting	17
Specifications	19
After-sales service	20
Bathtub Disposal	20
Warranty	21

Others



- Thank you very much for purchasing the FLOTATION TUB.
Please read this manual carefully and use the FLOTATION TUB correctly.
Keep this instruction manual for future reference.

Cautions and warnings



Always observe these warnings.



Please read these cautions and warnings carefully and use the equipment correctly. Follow all safety precautions and warnings.

- The following are the indicators and their meanings.



 WARNING	When this appears next to a topic, this indicates that misoperation could result in death or serious injury.
 CAUTION	When this appears next to a topic, this indicates that misoperation may result in injury or physical damage.



- The following symbols are used to classify and explain instructions that must be followed.

Symbol example	Meaning of symbol
	This symbol indicates something that is "Prohibited".
	This symbol indicates something that is "Required".

 WARNING	
 Do not disassemble.	<p>Do not try to disassemble, repair, or modify.</p> <ul style="list-style-type: none"> Otherwise there is a risk of injury, fire or electric shock due to abnormal operation. There is also a chance of leakage that could wet and cause damage to household property.
 Prohibited	<p>Do not let the person under the influence of drugs or strong pharmaceuticals bathe.</p> <ul style="list-style-type: none"> Otherwise there is a risk of drowning.
	<p>Ensure that no electrical appliances are plugged in near the bathtub.</p> <ul style="list-style-type: none"> Keep electrical appliances away from the bathtub. Otherwise there is a risk of injury, fire or electric shock due to abnormal operation of the electrical appliance.
	<p>Do not drain the bathtub while bathing.</p> <ul style="list-style-type: none"> Otherwise your hands, legs or hair might be drawn into the drain, with the possibility of injury or drowning.
	<p>Do not stand on the edge of the bathtub.</p> <ul style="list-style-type: none"> Otherwise, you may slip and hurt yourself.
	<p>Do not submerge yourself or thrash about in the bathtub.</p> <ul style="list-style-type: none"> Otherwise, injury or drowning may result.
	<p>Do not use flammable substances around the bathtub.</p> <ul style="list-style-type: none"> Otherwise, a fire could result.
	<p>Do not look directly into the LED lighting.</p> <ul style="list-style-type: none"> This may cause an eye injury.
	<p>Do not grasp the head rest when entering or exiting the bathtub.</p> <ul style="list-style-type: none"> The head rest could detach and cause an injury or result in drowning.
<p>Do not operate with the AIR-JET caps removed.</p> <ul style="list-style-type: none"> Water remaining in the pipes could splash up into the eyes or mouth, risking injury when draining the bathtub or when it is operated while the bathtub is empty. Properly attach the AIR-JET caps before operating. 	



 WARNING	
 Always observe	Ask your retailer, contractor or specialist about installing or moving the product <ul style="list-style-type: none"> • If you try to install or move it yourself and something has not been done properly, fire or electric shock could result. There is also a chance of leakage that could wet and cause damage to household property.
	Be sure to supervise children or anyone with limited physical, sensory or mental abilities at all times while they are taking a bath. <ul style="list-style-type: none"> • Failure to supervise means there is a risk of drowning.
	Hold the edges of the bathtub when entering. <ul style="list-style-type: none"> • Otherwise, you may slip and hurt yourself when getting into or out of the bath.
	Step in and out of the bathtub carefully. <ul style="list-style-type: none"> • Do not jump into the bathtub. Otherwise, you may slip and hurt yourself.
	Check the temperature of the water before entering the bathtub. <ul style="list-style-type: none"> • There is a risk of scalding.
	Check that the protective covers are fitted over the intake parts. <ul style="list-style-type: none"> • If the protective covers are not in place during use, parts of the body, hair, etc. may be sucked in, leading to drowning or injury.
	Do not block the intake parts. <ul style="list-style-type: none"> • Otherwise, hands, feet, hair, etc. May be sucked in, causing an unforeseen accident.
	Do not use the bathtub if the protective covers of the function module or the filter of the intake parts are damaged. <ul style="list-style-type: none"> • Doing so may lead to the hair being sucked in, or other injury.
	Be sure to clean the bathtub before it is used for the first time.
	Clean the bathtub regularly.
Ensure that there is adequate ventilation during and after bathing. <ul style="list-style-type: none"> • Otherwise, mildew may form. 	

 CAUTION	
 Prohibited	Do not aim the air bubbles directly at the eyes, nose or ears. <ul style="list-style-type: none"> • This may cause an inflammation.
	Do not hit or drop the plated parts. <ul style="list-style-type: none"> • Doing so could crack the plated surfaces, leading to injury. If the plated surface should ever crack, please replace the cracked part immediately with a new part.
	Do not sit on or climb onto the head rest. <ul style="list-style-type: none"> • Doing so could cause a fall or injury. Components may deform and/or break.
	Do not apply force to the protective covers of the function module or the filter of the intake parts. <ul style="list-style-type: none"> • Doing so may cause damage to the protective covers of the function module or the filter of the intake parts, causing the pump to stop, or causing an unforeseen accident such as the hair being sucked in.
	Operate the controller gently. <ul style="list-style-type: none"> • Use of excessive force could cause malfunction.
	Do not drop things into the bathtub. Do not bump, or impose undue force on the bathtub. <ul style="list-style-type: none"> • Doing so could cause cracking and leaks.
	Do not let hot water splash outside the bathtub. <ul style="list-style-type: none"> • Water splashing out of the bathtub could cause flooding outside the bathing area and problems in other rooms (mould, peeling wallpaper, flooring damage, etc.)
	Do not pour paint thinner, other solvents or chemicals down the drain. <ul style="list-style-type: none"> • Doing so could damage the pipes, leading to leaks.
	Do not use bath oils or bath salts containing sulphur, salts, or acids. <ul style="list-style-type: none"> • Doing so could discolour or deteriorate the bathtub or damage the pipes, leading to leaks.
	Do not use foaming, chlorine-based or anti-mould cleansers. <ul style="list-style-type: none"> • The gases that are produced in reactions with water or moisture can corrode or degrade the stainless steel or other metals.

 **CAUTION**



Prohibited

When cleaning, do not use the following cleansers or tools.

Doing so could cause product problems or an adverse reaction in people, depending upon how they are used.

- **Detergents labelled "acidity"**
These could cause discolouration, deterioration or staining of the surface.
- **Detergents labelled "alkalinity"**
These could cause discolouration, deterioration or staining of the surface.
- **Thinners, acetones, and other solvents**
These could cause discolouration, deterioration or staining of the surface. Additionally, there is also a chance of damaging the drain path and subsequent leakage.
- **Chemicals**
These could cause discolouration, deterioration or staining of the surface. Additionally, there is also a chance of damaging the drain path and subsequent leakage.
- **Detergents containing chlorine**
These could cause discolouration, deterioration or staining of the surface. It can also damage the plating of the water tap.
- **Unwoven sponges, aluminium sponges, net sponges, pumice sponges, metal bags, nylon bags**
These may scratch the surface of the bathtub.
- **Cleanser or polishing powders**
These will cause scratching.

Keep sources of heat at a distance.

- Do not put candles near the bathtub. Do not smoke. Otherwise there is a risk of deformation, discolouration or deterioration of the bathtub.

Do not leave items out that rust easily.

- Leaving hairpins, razors or other items that rust easily in the bathtub could leave rust marks that are difficult to remove on the surface.

Avoid powerful forces and impacts.

- Damage could lead to leaks, which could lead to water damage of household property.

Do not use inorganic drain cleaners / granulated detergent for removing clogging of piping.

- They may damage the pipes as well as the surface. They are dangerous to health when wrongly used. At most, use a biological drain cleaner, if a plunger is insufficient.

Do not dispose of any chemicals or drain away any objects likely to block the drain pipe in the bathtub.

- Observe the current environmental regulations of each country.



Always observe

Rinse the bathtub within 5 minutes after using cleanser.

- Otherwise there is a risk of discolouration, deterioration or cracking of the bathtub.

If cosmetics or similar substances get on the product, wash it with water immediately.

- Leaving cleansing agents, hairdressing products, hair dyes, hair tonics, perm solutions or essential oils on the surface could cause discolouration, deterioration or cracks.

When disposing the bathtub, the function parts, or any other parts, separate each component

- Dispose of the separated components according to the environmental laws in your country.

Safety precautions

Please observe the following.

Use only genuine parts with this product.

- Otherwise, an unforeseen accident could result.

Clean the bathtub well.

- If there is bath water residue, trace amounts of copper ions in the water could react with the fatty acids in the soap, causing a blue discolouration.

Clean out the intake part filter carefully.

- This is to prevent pump damage.



Prohibited

Do not cover the intake parts with a towel or wash cloth

- This can cause damage to the equipment.

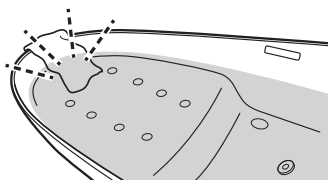

Prohibited

Do not block the nozzles + AIR-JET caps.

- Doing so could cause problems.

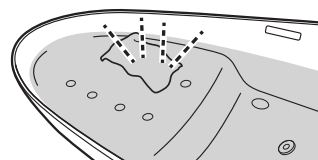

Prohibited

Do not apply pressure inside the nozzle or run water through it.

- Water could get inside the air pump and break it.



Prohibited

Do not pour hot water over the controller or subject it to impact

- Doing so could cause problems.

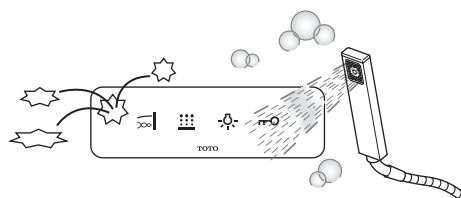

Prohibited

Do not pour hot water over the intake parts or other fittings or subject them to impact.

- Direct contact between the bathtub surface and hot water in excess of 60°C can damage the surface.
- Dropping or striking the tub with cosmetic bottles or other hard objects can cause scratches.

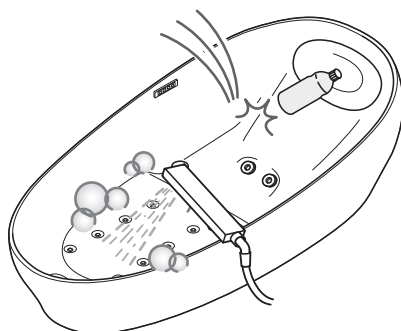

Prohibited

Do not use emulsion-type bath additives.

- White powder may remain inside the pump or plumbing fittings, causing cloudy water to spray out when using the AIR-JET, HYDROHANDS, or NECK BATH.
- For other types of bath additives, please read the instructions carefully and use them properly.



Prohibited

When using bathing soap, do not run the AIR-JET, HYDROHANDS, or NECK BATH.

- Doing so will generate a large amount of bubbles and the bubbles could remain in the pump or in the plumbing fittings.

Names of parts

Bathtub

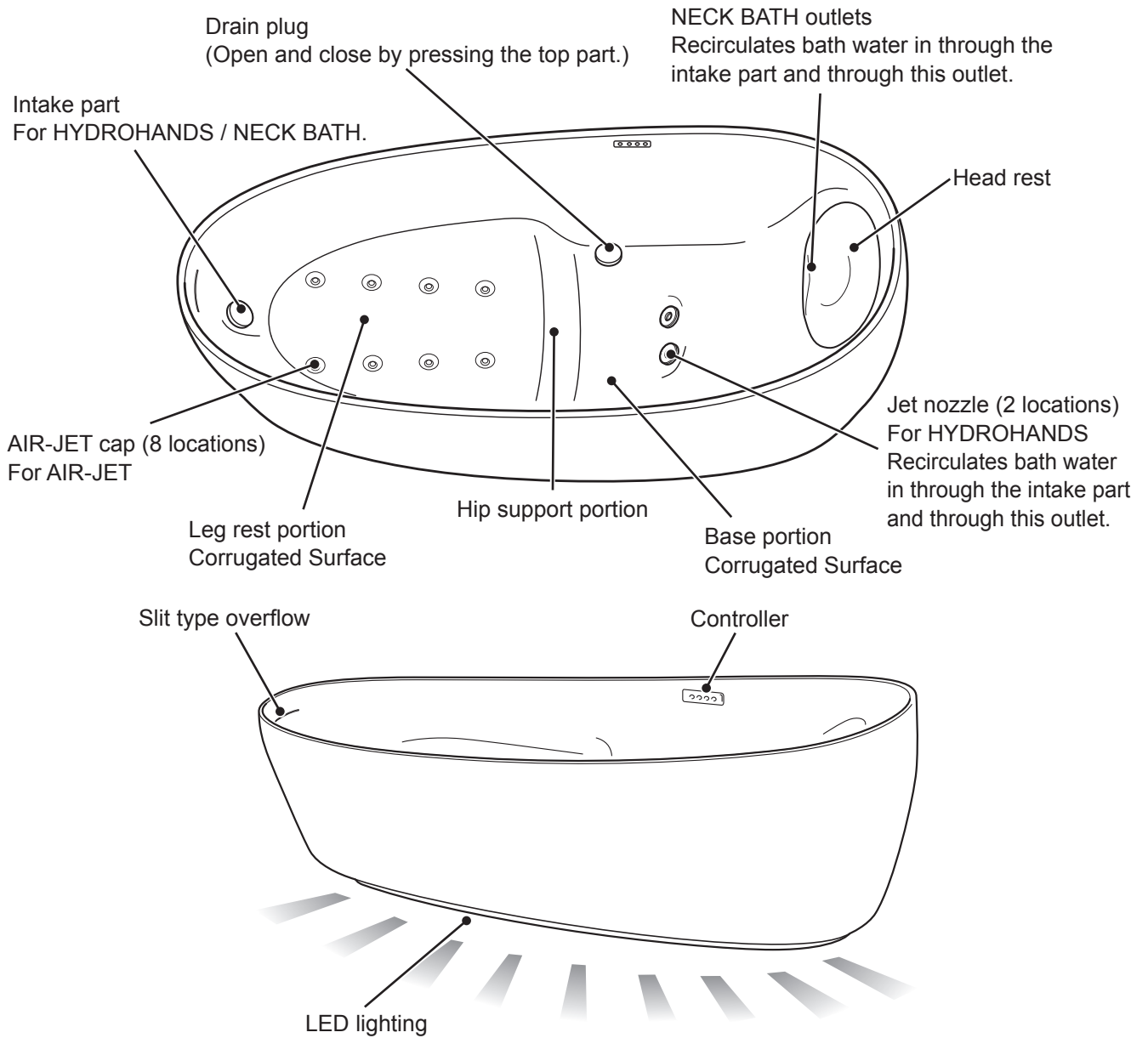

Controller

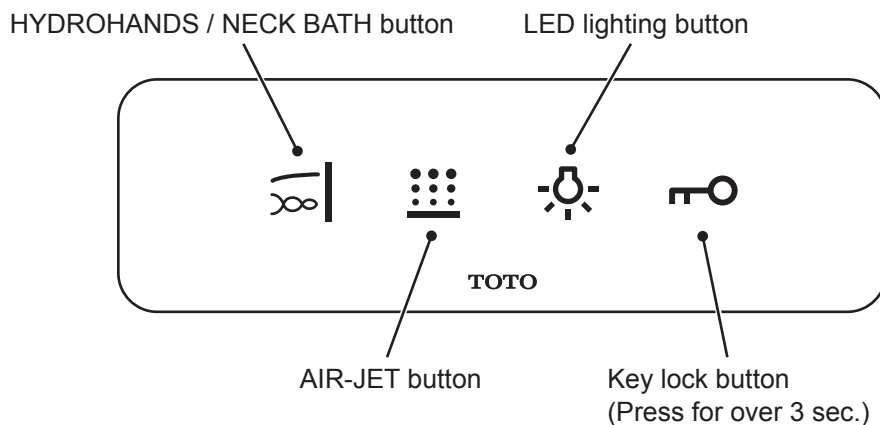

Before using it for the first time

Procedure for first-time use

Maintain the same water level in the bathtub when entering.

- If the water level is low then there may be some functions that do not work, such as the NECK BATH button.

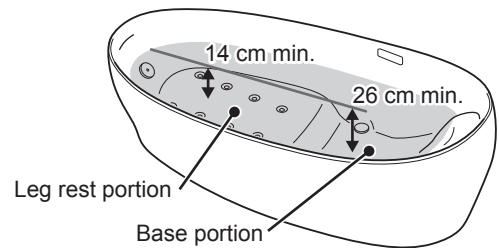

The bathtub has a head rest and concave surface for maintaining a proper bathing position in the bathtub.

- Adjust the hip support portion so that your body does not slide when sitting in the bathtub, and stabilize the head rest so that it matches the position of your head and neck.

*Please do not grasp the head rest when entering or exiting the bathtub. The head rest could detach and cause an injury or result in drowning.

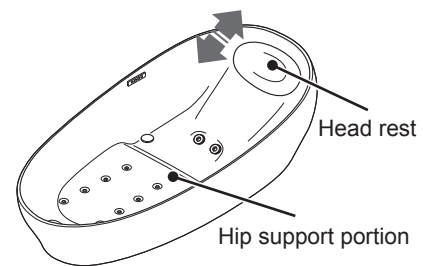

Example of the sequence of events when entering the bathtub

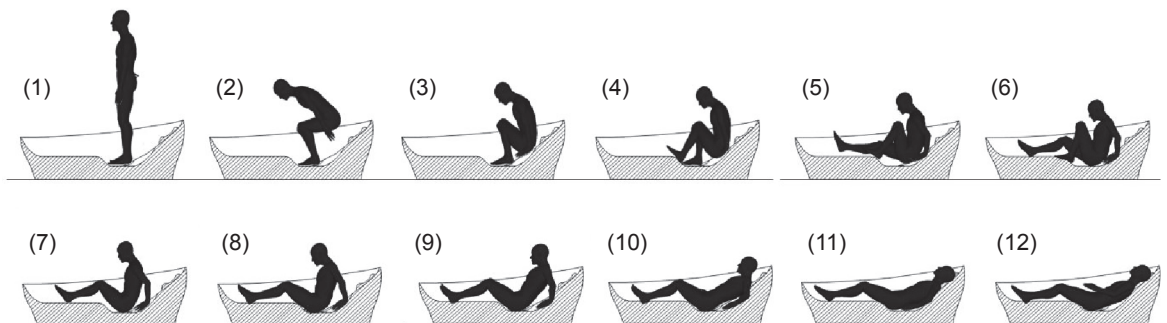

Enter and exit the bathtub from the leg rest and base portion.

- When entering or exiting the bathtub, do not step on the tilted part of the bathtub. You could lose your balance and cause an injury or result in drowning.

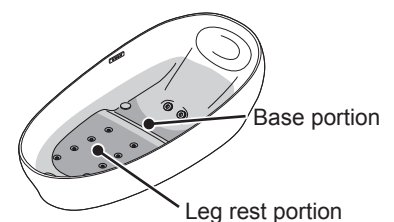

For a pleasant bathing experience, please change the water in the bathtub daily.

We also recommend draining the water out of the bathtub soon after bathing.

- If the water is frequently left in the bathtub until the next day or if the residual water is not removed due to the use of the shower during maintenance, residue could build up in the pipes or cause an offensive odour.

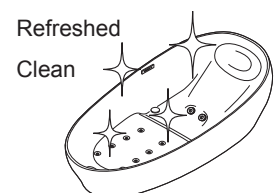

Enter the bathtub with a low temperature.

- The temperature may be higher than normal when using the HYDROHANDS / NECK BATH. Enter the bathtub with a low temperature.

How to use

Drain plug

Drain plug

The drain plug can be opened or closed by pressing the top part.

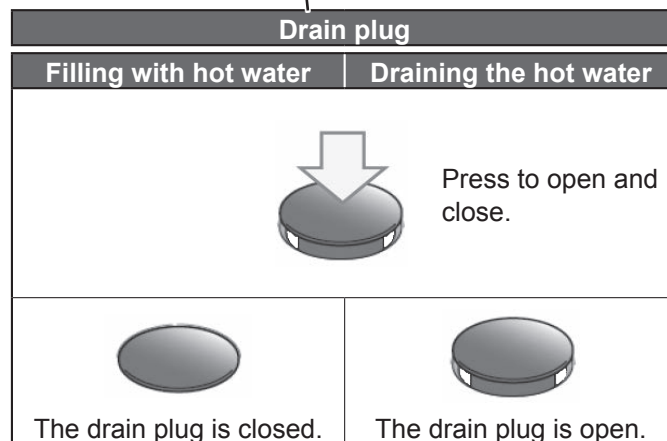
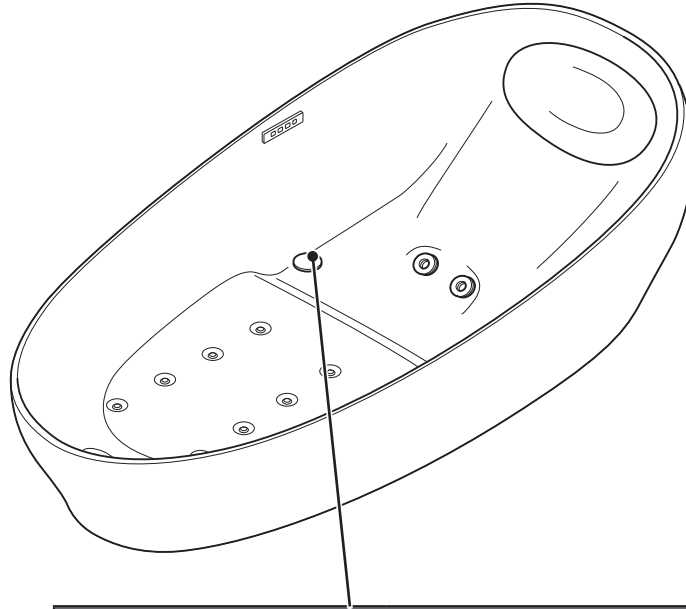

*Make sure no foreign particles enter the drain button.

*If foreign particles, hair, or residue enters the drain plug, remove them by following the instructions listed in the manual. ►P.16

HYDROHANDS and NECK BATH operation

HYDROHANDS / NECK BATH button

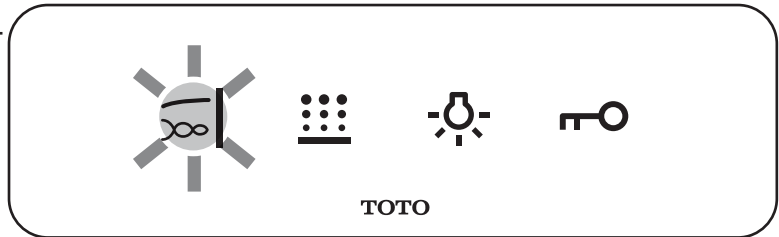
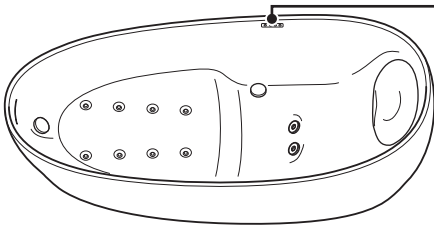

1. Fill the bathtub with hot water (Fill up the intake parts)

2. Touch 



The raised symbol will light up.

HYDROHANDS and NECK BATH will come out from the ejection jet nozzle and the NECK BATH outlets, respectively.

- The bathtub won't function unless it has water in it.
*Fill the water at least 14 cm above the leg rest portion, and at least 26 cm above the base portion (under 12 cm from the bathtub edges and surface).
- HYDROHANDS and NECK BATH are operated at the same time. These functions cannot be operated individually.
- As lukewarm water in the piping comes out when the operation is started, it may feel cool at first.
- After starting operations, the system will automatically stop after approximately 15 minutes has expired.

3. Touch  again



The raised symbol will turn off.

The HYDROHANDS and NECK BATH will turn off.

Residual water in the pipes after bathing

- After discharging the water in the bathtub, the residual water within the piping will be automatically discharged into the bathtub. ▶ P.14

AIR-JET operation

AIR-JET button

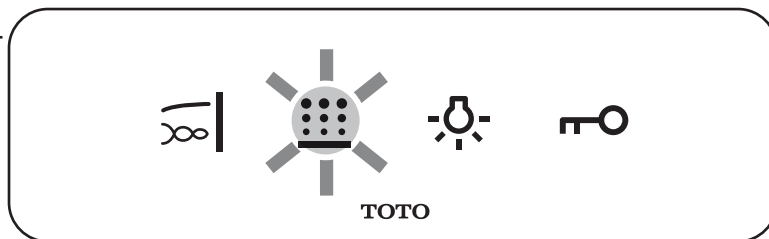
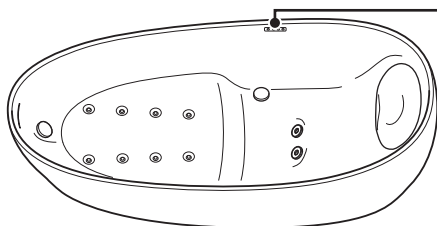

1. Fill the bathtub with hot water.

2. Touch 



The raised symbol will light up.

Air will come out of the AIR-JET cap. The initial setting is set at the Strong Mode.

- After starting operations, the system will automatically stop after approximately 15 minutes has expired.

3. Touch  again



The raised symbol will turn off, and then light up again.

The status will change to Weak Mode.

- After starting operations, the system will automatically stop after approximately 15 minutes has expired.

4. Touch  again



The raised symbol will turn off.

The AIR-JET operation will stop.

*The safety device will stop the operation when the air pump temperature increases abnormally.
In that case, consult your retailer, contractor, or TOTO described on the back cover.

Residual water in the pipes after bathing

- After discharging the water in the bathtub, the residual water within the piping will be automatically discharged into the bathtub. ► P.14

How to use the LED lighting

LED lighting button

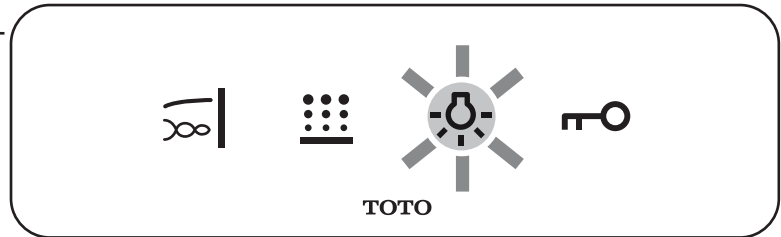
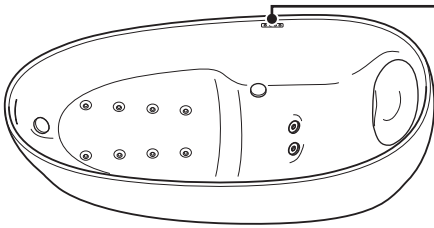

1. Touch 



The raised symbol will light up.

The LED lighting under the bathtub apron will light up.

- After starting operations, the system will automatically stop after approximately 15 minutes has expired.

2. Touch  again



The raised symbol will turn off.

The LED lighting under the bathtub apron will turn off.

How to use the key lock

Key lock button

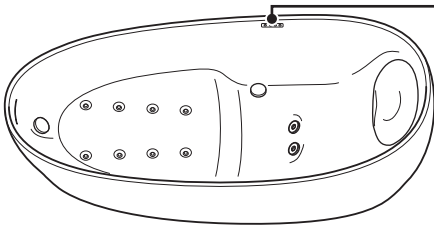

TOTO

1. Press  for over 3 seconds.



The raised symbol will light up.

All button operation is disabled.

2. Press  for over 3 seconds.



The raised symbol will turn off.

All button operation is enabled.

How to maintain

Method of maintenance

Bathtub maintenance

Cleaning the bathtub after bathing while the bathtub is still wet makes cleaning up easy. To keep the bathtub fresh and clean at all times, please clean it frequently.

Apply a "pH neutral" bathtub detergent with a sponge or cloth, wash, rinse with water within 5 minutes and then wipe dry.



HYDROHANDS / NECK BATH piping maintenance

If the HYDROHANDS / NECK BATH has gone without cleaning for a long time, flakes of dirt (residue) deposited in the pipes may be released into the bathtub. This is the result of a build-up of residue inside the pump or pipes. To avoid the build-up of residue, the pipes should be cleaned out about once a month using a commercially available pipe cleanser.

Controller maintenance

► P.15

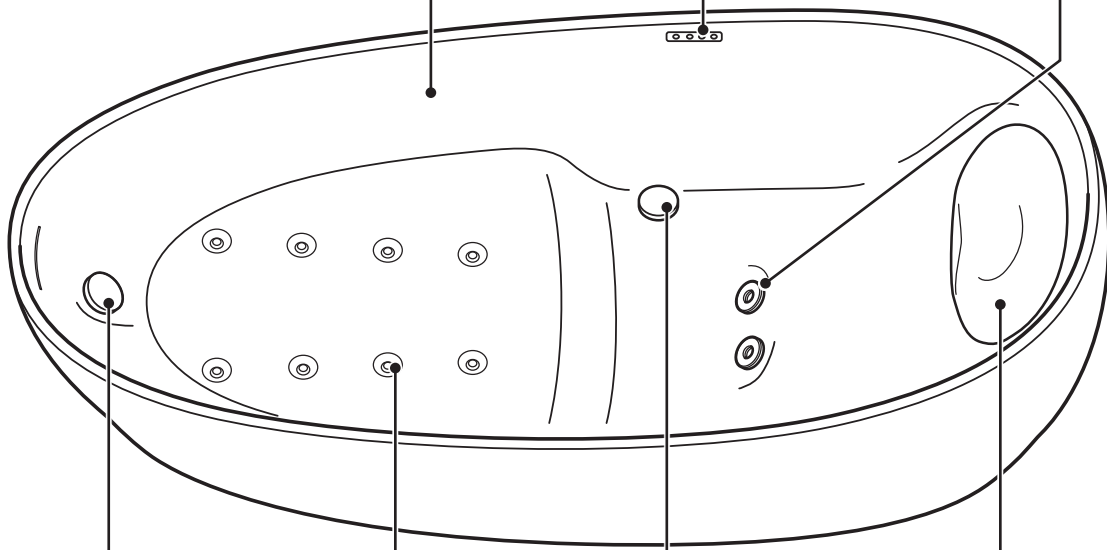

AIR-JET cap maintenance

► P.14

Drain plug maintenance

► P.16

Head rest maintenance

► P.15

Intake part maintenance

If the HYDROHANDS / NECK BATH has gone without cleaning for a long time, flakes of dirt (residue) deposited in the pipes may be released into the bathtub.

This is the result of a build-up of residue inside the pump or pipes. To avoid the build-up of residue, the pipes should be cleaned out about once a month using a commercially available pipe cleanser.



WARNING



Prohibited

Do not remove the intake part.

- Hands, feet or hair might become drawn in, causing injury or drowning.

*Dirt and debris on the water outlet may cause disorder in the water fall. Clean the water outlet using the included cleaning spatula for NECK BATH outlet to remove foreign matter around it.

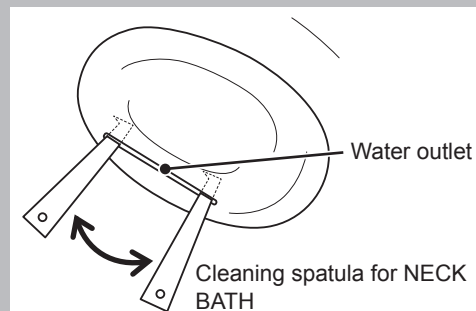

Drainage operation for AIR-JET piping

Residual water in the piping will be discharged automatically

After discharging the water in the bathtub, the residual water within the piping will be automatically discharged into the bathtub.

(About 5 minutes after discharging the water in the bathtub, automatic discharging will start. A purging operation is conducting for 1 minute.)

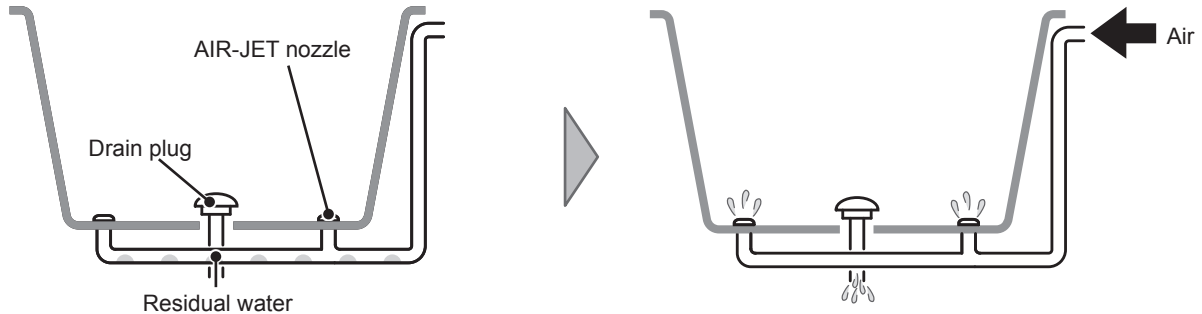

When cleaning the bathtub with a shower

You can empty the residual water inside the pipes to the bathtub using the AIR-JET operation.

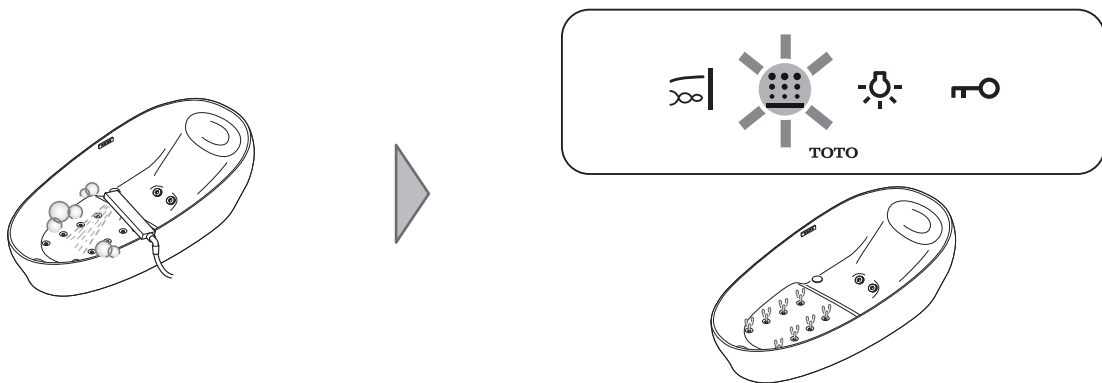

*Residual water in piping of HYDROHANDS / NECK BATH is discharged with water in the bathtub, so you do not need special operation for them.

AIR-JET cap

When the residue clogs the AIR-JET cap, the AIR-JET will have less power and will not be able to function sufficiently. If you find that the AIR-JET has less power, please clean it.

1. Drain all of the water out of the bathtub.
2. Remove the AIR-JET cap.
 - Please use a plastic spatula or similar object to remove the AIR-JET cap. Using your finger to remove it could hurt your finger or fingernail.
3. Clean the AIR-JET cap
4. Return the AIR-JET cap to where it was.

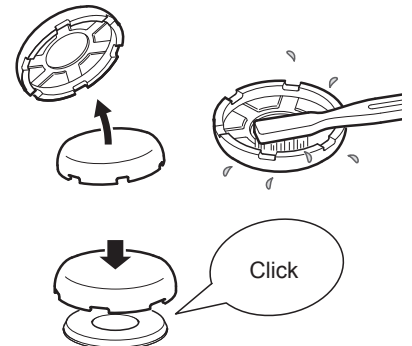

WARNING



Prohibited

Do not operate with the AIR-JET caps removed.

- Water remaining in the pipes could splash up into the eyes or mouth, risking injury when draining the bathtub or when it is operated while the bathtub is empty. Properly attach the AIR-JET caps before operating.



Controller

- Please use a soft, slightly damp cloth to wipe the unit.
- If it is badly soiled, use a suitable amount of diluted, neutral detergent on a cloth or sponge to wipe it clean.
- When cleaning, if the buttons react, please press the key lock button for over 3 seconds and make sure all other button operation is not accepted.
- The product is made of plastic, so please do not wipe it with a dry cloth or sponge. Doing so could cause scratches.

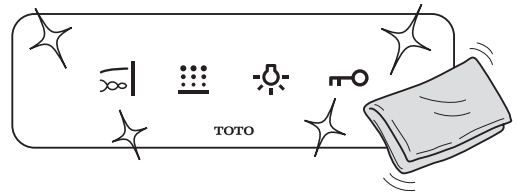

Head rest

- The head rest can be removed.
- Clean each part and the NECK BATH unit after removing the head rest.

1. Remove the head rest

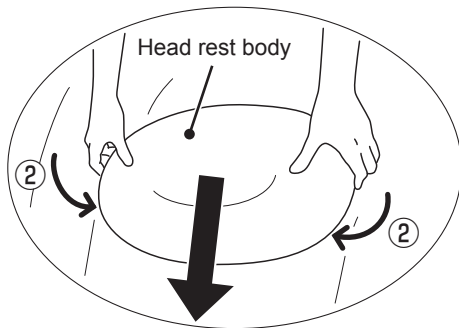

① Slide to the lowest position.

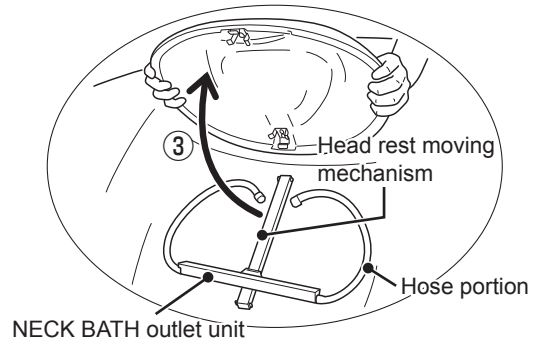

2. Clean the head rest

- Use mild soap and water on a clean, soft cloth for routine cleaning.
- Apply a "pH neutral" bathtub detergent with a sponge or cloth, wash, rinse with water within 5 minutes and then wipe dry.

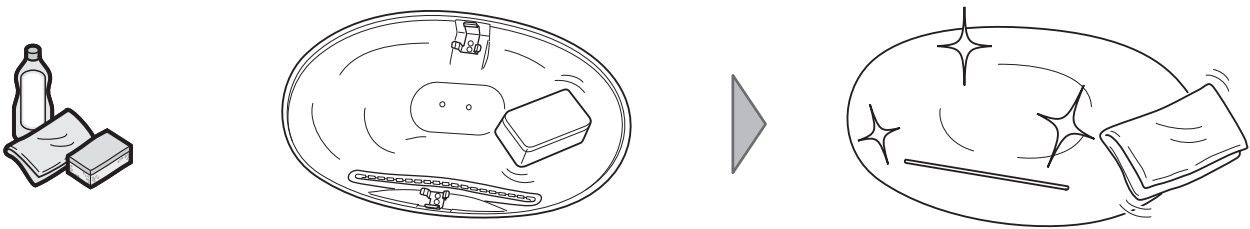

3. Return the head rest to where it was.

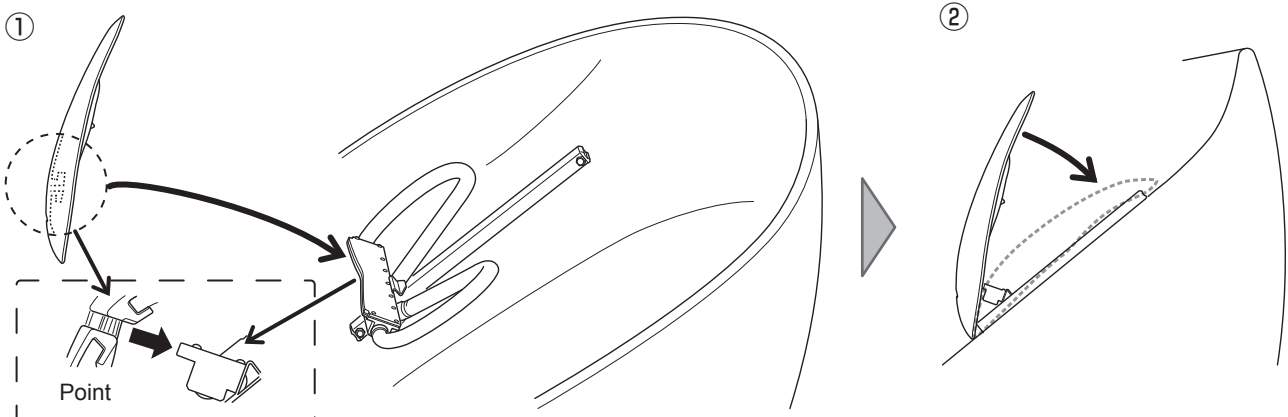

Drain plug

If foreign particles, hair, or residue enters the drain plug, remove it with the following procedures.

1. Remove the drain plug

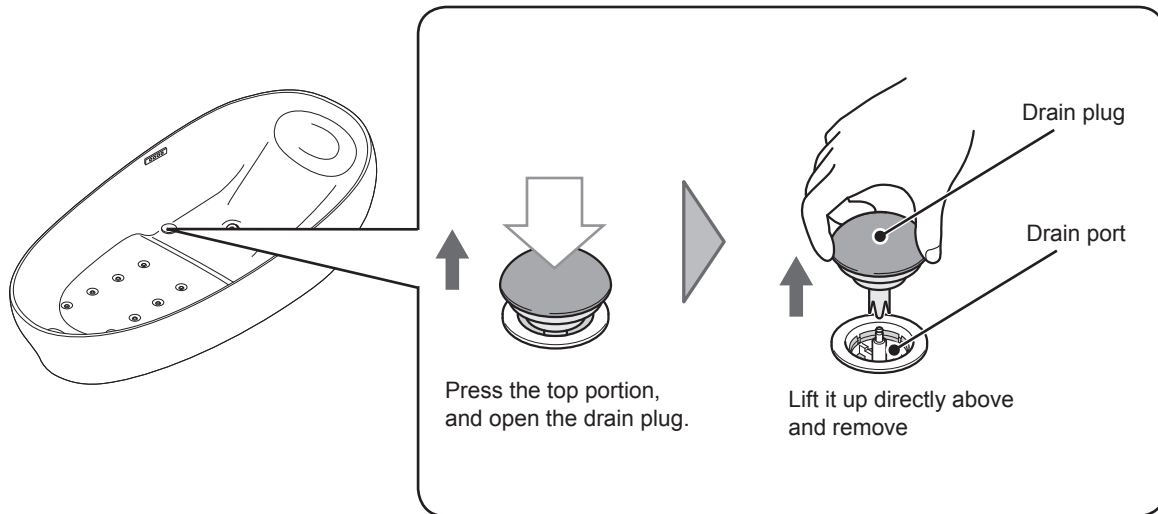

2. Clean the drain plug

- Use a brush to remove debris stuck in the drain plug or drain port and wipe it clean with a cloth.

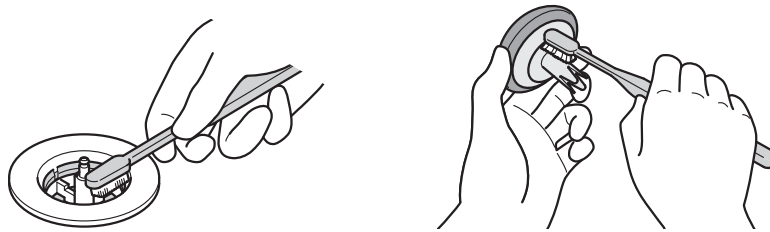

3. Return the drain plug to where it was

- Insert the drain plug until you hear a clicking sound.
- Press the top part of the drain plug and check that it opens vertically.

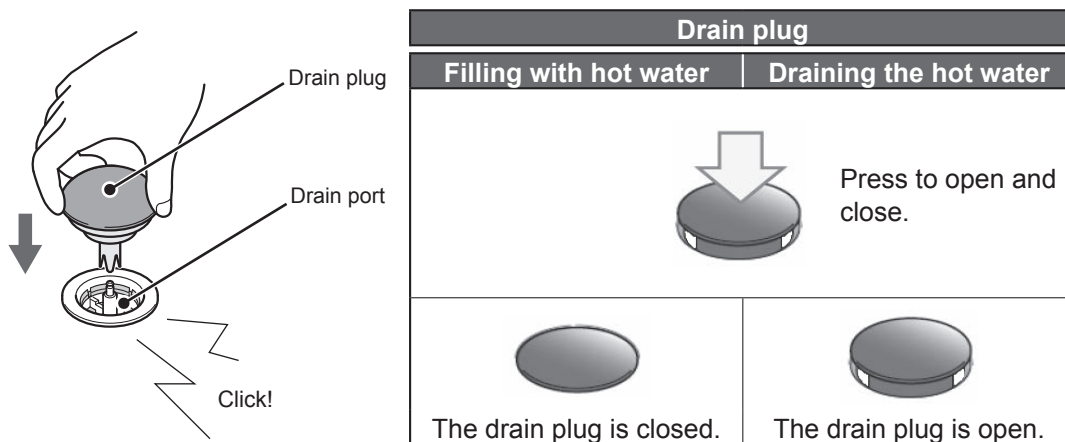

Troubleshooting

Please read this section to troubleshoot any problem before requesting repairs. If the issue is still not resolved, then please request repairs.

AIR-JET

No air bubbles come out of the AIR-JET.

- Is there debris or residue trapped in the AIR-JET caps? → Please clean the AIR-JET caps. ▶P.14
- The safety device will stop the operation when the air pump temperature increases abnormally. ▶P.10

This feature shuts off on its own.

- When the timer passes, it automatically stops. ▶P.10

This feature starts up on its own.

- Is the automatic draining operation running to drain the bathtub? ▶P.14

Cold water or cold air bubbles come out of the caps.

- Right after the feature starts, cold water that had been in the pipes might come out.
- The air bubbles near the AIR-JET caps on the bottom of the bathtub feel cool. Please adjust your bathing position.

The water in the bathtub goes cold sooner than expected.

- When using the AIR-JET, the water in the bathtub cools off quicker than when not using the AIR-JET.

HYDROHANDS and NECK BATH feature

It doesn't work.

- Is the water level in the bathtub low? → It will not work if the water level is low. Fill the bathtub with hot water up the intake parts. ▶P.7

This feature shuts off on its own.

- When the timer passes, it automatically stops. ▶P.9
- Operation may stop when the water level is low. → Please add water and increase the water level in the bathtub. ▶P.7

There is not much water flow volume.

- Is the intake part blocked? → Please clean it. ▶P.13

LED lighting

This feature turns itself off.

- When the timer passes, it automatically stops. ▶P.11

Controller

The lights on the controller do not work.

- Is the circuit breaker for the power supply turned off? Has there been a power outage?

The buttons do not respond.

- Are you using just your fingertips to operate?
→ Make sure to use the ball of the finger when touching the buttons.
- Are you pressing the button along the edge or in a corner?
→ Please press near the little raised symbol.
- If you press more than one button at the same time, they will not respond.
- The buttons may not respond if you are wearing gloves.
- Is there dirt or debris on the button? Is there something nearby, a towel for example that is interfering with the operation?
→ Remove any obstruction.

Buttons respond without being touched.

- In rare instances, the buttons may respond to contact with water.
→ Operate to restore the original settings.

Specifications

Item	Specifications	
External dimensions	2200 mm(L)×1050 mm(W)×780 mm(H)	
Bathtub depth	394 mm	
Capacity	293 L	
Weight	170 kg	
Materials	GALALINE (GALALINE is an artificial marble made of GFRP sandwich structure.)	
Drainage method	Normal drainage (partial electrical valve automatic drainage) + Overflow drainage	
Drain plug	Push-operated drain plug	
Drainage rate (with trap)	48 L/min	
Overflow rate (with trap)	48 L/min	
AIR-JET	Number of jet ports	8 locations
	Ejection air amount	Approx. 400L/min. (Strong mode) Approx. 250L/min. (Weak mode)
NECK BATH (Circulation)	Number of intake parts	1 location
	Number of water outlets	1 location
	Water discharge flow rate	Approx. 18 L/min
HYDROHANDS (Circulation)	Number of intake parts	1 location
	Number of water outlets	2 locations
	Water discharge flow rate	Approx. 60 L/min
LED lighting	Irradiation part	1 location
	Irradiated colour	1 colour
Controller	Electrostatic capacitance-type touch panel	
Rated voltage	220-240V AC	
	Philippines/Saudi Arabia 220V AC	
Rated frequency	50 Hz	
	Philippines/Saudi Arabia 60 Hz	
Rated current	3.5-4.0 A	
	Philippines/Saudi Arabia 4.0 A	
Rated power consumption	700-850 W	
	Philippines/Saudi Arabia 850 W	
Standby power consumption	2.8 W	
Safety devices	Continuous operation preventing device Overcurrent protection device Overheating protection device (thermal protector)	



After-sales service

About the warranty

The instruction manual is also the warranty. Confirm the "installed store name/delivery date", read the warranty carefully, and store it in a secure location. ▶P.21

Inquiring about the product, purchasing service parts, and requesting repair

Request the dealer or contractor from whom you purchased the product. Alternatively, contact TOTO using the information on the back cover of this manual.

<Contacting Us>

- Name, address, and telephone number
- Product name and date of receipt (See warranty) ▶P.21
- Malfunction details and error status
- Desired date of visit

Holding period of service parts

The minimum holding period of the service parts for this product is 5 years after the end of production. Service parts are parts that help preserve the product's functions.

Parts replacement

The parts and components removed with the free repairs will be the property of TOTO.



Bathtub Disposal

Request an authorized waste service company when disposing of this bathtub.

Separate the parts that comprise the bathtub (bathtub, function parts, and other parts).

*Observe the current environmental regulations of your country when disposing the separated parts.

TOTO

Warranty

<Warranty is valid for 1 year only>

- [1] TOTO will honour the warranty for a period of one year if the product malfunctions during normal use or maintenance. The warranty applies only to customers who have purchased the product directly.
- [2] Assuming correct installation and use of the product according to the instruction manual, TOTO will be responsible for any repairs or replacements of the product or parts verified as defective according to TOTO as per the warranty. TOTO reserves the right to investigate if it is necessary to identify the cause of the defect. TOTO will not request reimbursement for the work or parts relating to these repairs or replacements. However, TOTO cannot be held responsible for the costs of disposal of the product, the return of products or parts, or reinstallation.
- [3] A fee will be charged for the following repairs even if within the warranty period.
- (1) Accidents and damage caused by defective maintenance or failing to obey the warnings and cautions in the instruction manual.
 - (2) Accidents and damage caused by use of the product outdoors
 - (3) Accidents and damage due to repairs, disassembly, remodelling and relocation by other than a specialist
 - (4) Accidents and damage due to defective management until the day of handover when installation is complete
 - (5) Nonconformances due to the consumption and wear of consumables (O-rings, rubber plugs, drain plug gaskets, etc., that are used daily)
 - (6) Discolouration due to wear over time, and deterioration of appearance concomitant with wear, mold, the adhesion of dirt, and use
 - (7) Damage or loss due to buildup or contamination included in the water supply system
 - (8) Malfunction and damage due to conditions (power supply, water pressure, etc.) other than those specified in the regulations
 - (9) Malfunction and damage due to accidents such as fires and explosions, force majeure such as earthquakes, water damage, lightning, and freezes, etc., pollution, gas damage (hydrogen sulphide gas, chlorine gas, etc.), salt corrosion, and voltage errors, etc.
 - (10) Malfunction and damage due to feeding water that does not conform to the potable water quality standards determined in the laws concerning waterworks, such as hot spring water and well water, etc.
 - (11) Malfunction and damage due to animals such as rats and insects, etc.
 - (12) Malfunction and damage due to freezing if the product does not have cold region specifications
 - (13) Malfunction and damage due to phenomena that could not be predicted by the technology used at the time of the contract, or accidents caused thereby
 - (14) Malfunction and damage notified after the warranty has elapsed, or that were not notified promptly after their occurrence according to the relevant parts of the warranty
 - (15) If information deemed necessary for the warranty has not been written, or the text has been rewritten
 - (16) If the warranty is not supplied
- [4] This warranty applies the specific legal rights of the customer. Further, there may also be other rights depending on the country.
- [5] To receive warranty repairs based on this document, attach a document clearly describing the details of the malfunction and transport or ship the product to the TOTO service centre at your own cost, or contact your TOTO dealer, the installation store, or a TOTO vendor directly.
If the product cannot be returned to TOTO because of the dimensions of the product or for reasons of defective quality, the product shall be viewed as delivered when TOTO receives the written notice of the defect. If this applies, TOTO may either repair the product at the customer's location, or choose to pay the costs of transporting the product to the service centre themselves.
- [6] This warranty will not be reissued, so store carefully so that it is not lost.
- [7] The parts and components removed with the free repairs will be the property of TOTO.

This document is the sole warranty supplied by TOTO. Repairs or replacements supplied based on this warranty are the sole legal remedy that can be used by the customer who purchased the product.

TOTO cannot be responsible in any of the following cases for losses due to the use of the product.

- Accidental, specific, or secondary damages of losses incurred by the purchaser of the product
- Construction fees or other costs concomitant with installation or removal
- The cost of third-party repairs
- Any other expenses not described above

Further, depending on the country, limits to the tacit warranty period, or exemptions or limits to incidental or secondary damage, may not be recognized, so in such cases, the aforementioned limits and exemptions shall not apply to the customer.

TOTO

**TOTO ASIA OCEANIA PTE. LTD.
REGIONAL OFFICE**

10, Eunos Road 8, #12-07, Singapore Post Center. Singapore 408600.
Phone : +65-6744-6955 Fax : +65-6841-0819
<http://oceania.toto.com/>

**TOTO ASIA OCEANIA
DUBAI BRANCH**

LOB 19-1701,02,Jebel Ali Free Zone, P.O. Box 261804, Dubai,
United Arab Emirates
Phone : +971 4 886 5983 Fax : +971 4 886 5986
<http://oceania.toto.com/>

**TOTO ASIA OCEANIA
MANILA BRANCH**

Unit 1010, 10th Floor Rufino Buildings,Ayala Avenue corner V.A. Rufino
Street.
Makati City, 1226, Philippines
Phone : +63 2 887 6643 Fax : +63 2 887 4084
<http://oceania.toto.com/>

**TOTO ASIA OCEANIA
Yangon Branch**

#303, Prime Hill Business Square, No.60, Shwe Dagon Pagoda Road,
Dagon Township, Yangon, Myanmar
Phone : +95-1 382710 / +95-1 382720 Fax: +95-1 382638
<http://oceania.toto.com/>

**TOTO India Industries PVT. LTD.
Head Office**

101 Kamla Executive Park, Opposite Vazir Glass Works, Andheri Kurla Road,
Andheri (E), Mumbai 400059, India
Phone : +91-22-2832-5741/5742 Fax : +91-22-4022-3719
<https://in.toto.com/>

**TOTO (Thailand) Co., Ltd.
Spare Part
and After Service Center
(Head Office Saraburi)**

77 Moo 5 HSIL Industrial Zone T.Nong-Plamor, A.Nong-Khae, Saraburi
18140 Thailand
Phone : +66 92-246-5880, +66 92-246-6612, +66 36-382-760
Fax : +66 2-650-9923
<http://www.toto.co.th/>

**TOTO VIETNAM
Co., Ltd.**

Unit 1104, 11th Floor, Eastern Tower, Lotte Center Hanoi, 54 Lieu Giai Str.,
Ba Dinh Dist., Hanoi City
Phone : +84 4 3771 4354 Fax : +84 4 3771 4355
<http://www.toto.com.vn>

- You are advised to record the following information to allow quick service.

Date of purchase :	Name of shop :
Data: year month day	
	Phone :