

TOTO

Installation Manual

Bathtub

Please install the product properly ,in accordance with the descriptions in this manual so that full use can be made of the product's functions.

After installing the product,please tell the customer how to use the product fully.

- Thank you for choosing to use the TOTO BATHTUB on this occasion.
- Please install the product properly, in accordance with the descriptions in this manual so that full use can be made of the product's functions.
- After completing the construction, please explain the operation to the customer and give this Installation Manual and the accompanying "Instruction Manual" to the customer.
Note also: Please be sure to fill in the required items in the warranty.
- Please be aware that the parts numbers listed in the Installation Manual may be revised.

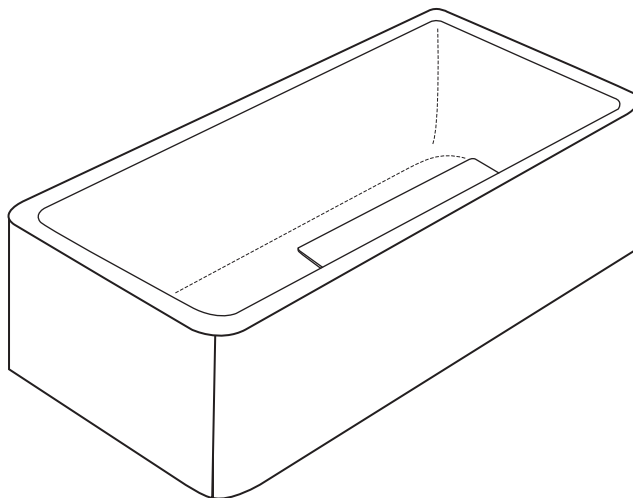



1.Important Safety Instructions.

Read and follow all instructions.Save this instruction with your instruction manual.



INSTALL TO PERMIT ACCESS FOR SERVICING.INSTALL THIS NUIT IN ACCORDANCE WITH THE NATIONAL ELECTRICAL CODE (NEC) NFPA 70 AND CANADIAN ELECTICAL CODE PART 1.

Please read these "Important safety instructions" carefully before begining the installation work and install the product correctly.

This installation Manual has a number of different symbols intended to allow proper ang safe installation of the product,to prevent harm to the end user,to prevent damage to property and to prevent harm to construction workers.these symbols have the following significance.

Symbol	Meaning
 Warning	This symbol indicates that errant handling after disregarding this symbol could result in death or serious personal injury.
 Caution	This symbol indicates that errant handling after disregarding this symbol could result in personal injury or cause physical damage.



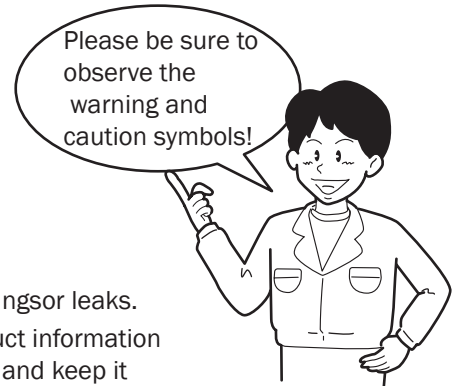

The following symbols can be found in the Installation Manual or on the product and are intended to help the construction worker install the product safely and properly. Please read the descriptions carefully and install the product correctly.

Symbol	Meaning
	Indicates "prohibited" activity that must not take place.
	Indicates "required" activity that must not take place.















After completing the installation,please check for safety problems such as loose fittings or leaks.



The Instruction Manual that is packed with the product is a valuable source of product information to help the end user use the product safely and coorectiy.Please take god care of it and keep it from gettinBefore bathtub completely installed into position, drain tool should be firstly installed and further installation can be continued after non-leakage g lost or soiled.After the construction is complete,please give the manual to the end user o r the construction superintendent.

 Warning	
 Always do this	After opening the box,please immediately dispose of unneeded packaging. Wooden frames,nails,cardboard or sealing straops could cause injury. Additionally,childer or pets might put vinyl bags over their heads, leading to unanticipated accidents. 
	Always implement the countermeasures for preventing freezing. It is possible that the pipes could freeze,rupturing the pipes or equipment.
	If installing the product in a location where damage from water leaking from the unction module is anticipated,be sure to waterproof the floor . If there were to be a leak,it could damdge the floor or floors below.
 Prohibited	Use no water other than standard tap water. The use of well water could cause corrosion,which could lead to leaks.
	Cement is absolutely not allowed to be used to erect bathtub. Otherwise it may cause crack of bathtub.
	The sticking of fittings such as inlet pipe and drain pipe etc. shall be solid. Otherwise it may cause water leakage.

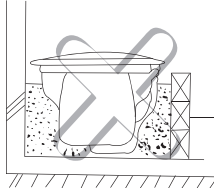
2.Construction On The Installation Point Of Attention.

 Warning		
 Always do this	<p>Install the product securely,in accordance with the Installation Manual.</p> <p>Improper installation can cause leaks that damage or ruin household property.</p>	
	<p>Install the drainage pipes securely,in accordance with the procedure.</p> <p>Improper installation could lead to leaks that damage or ruin household property.</p>	
	<p>Ensure that there is no abnormal condition before erecting bathtub.</p>	
	<p>Paper plate should be used for protecting bathtub prior to finishing construction.</p> <p>Otherwise damage may be caused.</p>	
 Prohibited	<p>Improper installation could lead to leaks that damage or ruin household property.</p> <p>Otherwise poor drainage may be caused or family property be contaminated by water leakage.</p>	
	<p>Do not drop or strike the bathtub with hard objects.</p> <p>Doing so could crack or scratch the bathtub or cause leaks that damage or ruin household property</p>	
	<p>Do not stand on bathtub while working.</p> <p>Doing so could cause one to slip and fall or could otherwise damage the product.</p>	
	<p>When cleaning,chemicals such as acid,alkaline and organic solvent as well as acid and alkali cleaner is forbidden,otherwise product surface may be damaged.</p> <p>When cleaning,water or neutral cleaner is recommended for use.Cleaning cloth dipped with a little alcohol can be used for removing smudge when water or neutral cleaner failed to removing smudge</p>	
	<p>Burning objects,please do not put on the bathtub.</p> <p>Otherwise damage may be caused.</p>	
	<p>On the back of bathtub mortar is forbidden to be used for filling and burying.</p> <p>Otherwise damage may be caused.</p>	

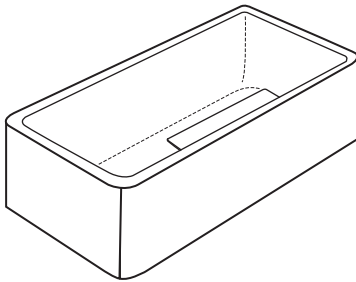
3.Parts list

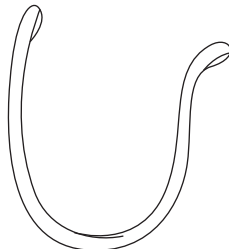
Name	Quantity	Type	Remark
Bathtub	1		
Installation manual	1		NTE026
Operation Installation	1		NTE141
Ribbon	1		It is used during transportation of bathtub.

Drainage fittings : Special pedal type drainage fittings

Material:FRP, artificial marble etc.

Color:Standard bathtub is matt white color.

Standard (QB) : Up to or over light industry standard of People's Republic of China (JC/T 779-2010)

4. Installation procedure

4-2. Installation of drain tube

Drain end of drainage fittings is inserted into ground drain tube for closely connection. If drain end is too short, connection pipe can be used for insertion.

● For direct draining occasions, thread pipe is connected.

①. Connecting PVC pipe

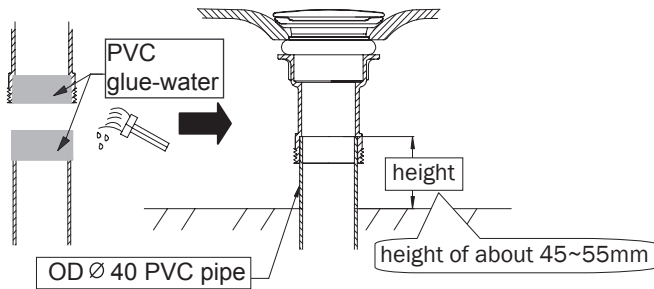

②. Connecting thread pipe

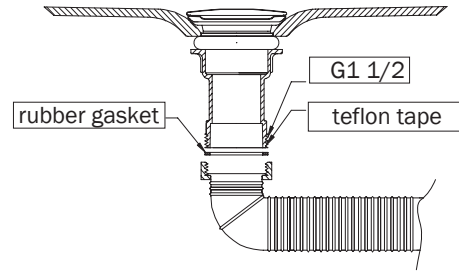

● For side draining occasions, thread pipe is connected.

①. Connecting PVC pipe

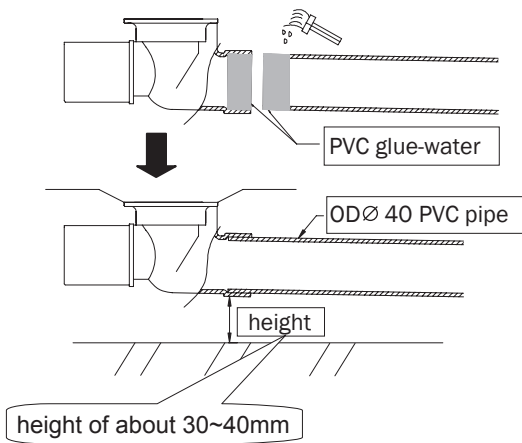

②. Connecting thread pipe

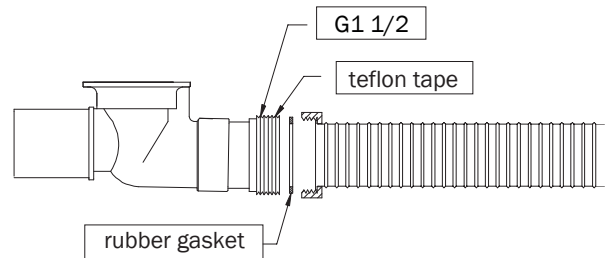

NOTE: We only provide the straight drain elbow, however, customer need to buy the side drain elbow if they need.

▴ pipe tilt 1/50 or more



Always do this

Special connecting glue-water of PVC pipe must be used for sticking, fixing and sealing the connected part between drain pipe and drain tool to avoid water leakage.

4-3. Fix the foot of bathtub with mortar

1. Measure bathtub with level bar.

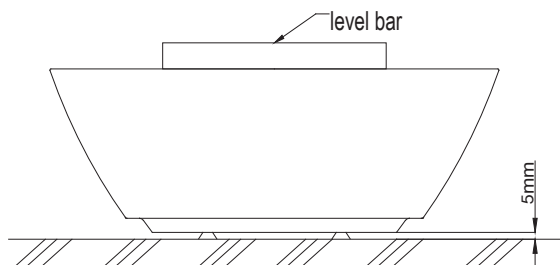

* Note: (1). Ensure space larger than 100mm over outer dimension of bathtub.
 (2). Adjust leveling of bathtub with level bar. Keep about 3mm for clearance between bathtub edge near wall and wall surface or masonry surface

2. Adjust leveling of bathtub with adjustable wrench.

The adjusting method for supporting foot:

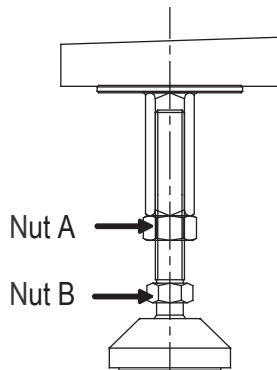

①. Screw off the nut A;

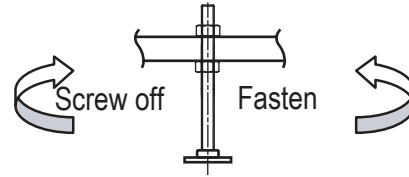

②. Adjust the nut B to the required position.

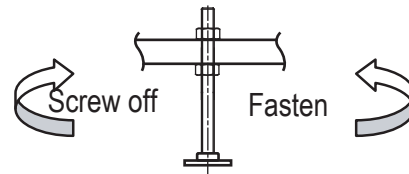

③. Fasten the nut A.

3. Coat all -purpose adhesive onto marked ground with $\Phi 30\text{mm}$ for each place.

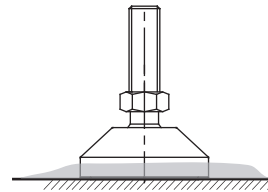
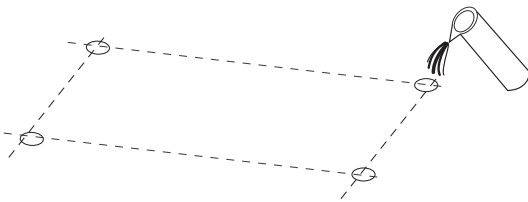

* Note: After installation of bathtub is completed, firstly clean floor, then clean bathtub with rag dipped in neutral detergent in order to keep cleaning and beauty of bathtub.



Warning

1. During the whole installation soft material is recommend to cover bathtub surface to prevent surface scratching.
2. Ensure that surrounding edges of bathtub not supply upward supporting force.
3. During installation bathtub is forbidden to collide with hard material and hard material not falling into bathtub.
4. The back of bathtub can not be filled or buried by mortar otherwise damage may be caused.
5. Never make construction by standing on bathtub or place heavy material on the edge of bathtub otherwise damage may be caused.