

TOTO

TOTO U.S.A., Inc. 1155 Southern Road Morrow, GA 30260
Phone : (770) 282 8686

Warranty Registration and Inquiry

For product warranty registration, TOTO U.S.A. Inc. recommends On-Line Warranty Registration. Please visit our web site <http://www.totousa.com>. If you have questions regarding warranty policy or coverage, please contact TOTO U.S.A. Inc., Customer Service Department, 1155 Southern Road, Morrow, GA 30260 (888) 295 - 8134 or (678) 466 - 1300 when calling from outside of U.S.A.

TOTO ASIA OCEANIA PTE. LTD. 10, Eunos Road 8, #12-07, Singapore Post Centre. Singapore 408600.
Phone : +65-6744-6955 Fax : +65-6841-0819 <http://asia.toto.com/>

TOTO ASIA OCEANIA PTE. LTD. Middle East Branch LOB19-1701-1702, Jebel Ali Free Zone, P.O. box 261804, Dubai U.A.E.
Phone : +971-4-886-5983 Fax : +971-4-886-5986 <http://asia.toto.com/>

TOTO ASIA OCEANIA PTE. LTD. Manila Representative Office. Unit 1010, 10th Floor Rufino Building, Ayala Avenue cor.V.A. Rufina Street, Makati City, 1226 Philippines.
Phone : +63-2-887-6643 Fax : +63-2-887-4084 <http://asia.toto.com/>

TOTO LTD. Bangkok Representative Office G & 7th FL., Q.House Ploenjit Building, 598 Ploenchit Road, Lumpini, Pathumwan, Bangkok 10330 Thailand
Phone: +66-2-650-9925 Fax : +66-2-650-9923
<http://www.totobkk.com/>

TOTO INDIA INDUSTRIES PVT. LTD 101, Kamla Executive Park, Opp. Vazir Glass Works, Off. Andheri Kurla Road, Andheri (East), Mumbai 400 059, India.
Phone : +91-22-4022-3717 / 3718 Fax : +91-22-4022-3719 <http://asia.toto.com/>

TOTO VIETNAM Co., Ltd. R. 810, Daeha Business Centre, 360 Kim Ma St., Ba Dinh Dist., Ha Noi City
Phone : +84-4-37714354 Fax : +84-4-37714355 <http://toto.com.vn/>

TOTO (H.K.)LTD. RM.1101, 11/F No.3 Lockhart Rd. Wanchai, Hong Kong
Phone : 852-2861-3177 / Fax : 852-2861-3563

- You are advised to record the following information to allow quick service.

Date of purchase :	Name of shop :
Date : year month day	Tel : ()

2013.6.7
D08756

TOTO

NEOREST

Instruction Manual



NEOREST

750H SN993MX
(MS993CUMFX)
TCF993WA

700H SN992M
(MS992CUMFG)
TCF992WA



- Thank you for your recent purchase of the TOTO NEOREST. Please read the enclosed information to ensure the safe use of your product.

- Be sure to read this Instruction Manual before using your product and keep it in a safe place for future reference.

The available functions vary according to the model.

✓ Check your model name and write a check mark in this field as needed.

The model name and part number are indicated on the bottom side of the toilet lid.

■ **Product model number**

Top unit + Bowl unit = Combination model number *
 SN○○○○ CT○○○○ MS○○○○
 TCF○○○○ CW○○○○

* Combination model number is for U.S. only.



Functions		Model		Ref. Page	
		NEOREST			
Your Model		Part No.	SN993MX TCF993WA	SN992M TCF992WA	
Basic Functions	Cleansing	Rear cleansing			16
		Rear soft cleansing			
		Front cleansing			
		Wide front cleansing			
	Changing the washing method	Wand position adjustment	●	●	
		Water pressure adjustment			
		Oscillating cleansing			
		Pulsating cleansing			
		Personal setting lock			
	Drying	Warm air drying	●	●	
Changing the temperature	Temperature adjustment	●	●	24, 25	
Sanitary Functions	"ewater+" sanitizing	Auto wand cleaning	●	●	20, 21
		Auto bowl cleaning	●	●	
	Maintaining the bowl unit cleanliness	Photocatalyst cleaning	●	-	
	Removing odors	Deodorizer	●	●	
Convenient Functions	Flushing	Remote control bowl unit cleaning	●	●	17 22, 23
		Auto bowl unit cleaning			
	Opening and closing	Opening and closing the toilet seat with remote control			22, 23
		Auto open / close (lid)	●	●	
	Lighting up	Soft light			
	Heating the toilet seat	Heated seat	●	●	-
	Saving energy	Timer energy saver	●	●	26, 27
		Auto energy saver			
Maintenance	Bowl unit cleaning	●	●	32	
	Wand cleaning			35	

Cleaning Support Sanitary Toilet

The "ewater+" feature and "photocatalyst cleaning*" keep the toilet bowl clean at all times.



CLEAN

UV lamp *

Mist

Photocatalyst coat *

The self-cleaning functions operate automatically. (See pages 20 and 21 for details.)

- | | | |
|--|--|---|
| As you approach and sit <ul style="list-style-type: none"> A mist is sprayed in the bowl unit to make it more difficult for dirt to adhere. When you sit on the toilet seat, the deodorizer operates. | As you stand up <ul style="list-style-type: none"> The wand is cleaned with "ewater+." (The wand extends and then retracts.) | As you move away <ul style="list-style-type: none"> "ewater+" is sprayed in the bowl unit to maintain cleanliness. The UV lamp lights up for about 1 hour. * |
|--|--|---|



Table of Contents

Safety Precautions	4	Introduction	
Operational Precautions.....	11		
Parts Names	12		
Preparation.....	14	Operation	
Basic Operations	16		
Automatic Functions (Cleaning Features).....	20		
DEODORIZER, AUTO WAND CLEANING, AUTO BOWL CLEANING, BOWL LIGHT, PHOTOCATALYST CLEANING, CLEAN INDICATOR			
Automatic Functions (Convenience Features).....	22		
AUTO FLUSH, AUTO OPEN/CLOSE, SOFT LIGHT			
Temperature Adjustment.....	24		
Energy Saver Features.....	26		
Power Plug	30		Maintenance
Top Unit.....	31		
Bowl Unit	32		
Bowl Unit cleaning			
Water Filter Drain Valve	33		
Deodorizing Filter	34		
Wand	35		
Wand cleaning			
Water filter	36	Reference	
Changing Settings	38		
What to Do?.....	50		
● If the water does not flow due to a power failure.....			50
● If the water does not flow due to a water service interruption			52
● If you cannot operate with the remote control			53
● Freeze Damage Prevention .			54
● Long Periods of Disuse		56	
Troubleshooting.....	57	Specifications	
Specifications	65		
Warranty	66	Warranty	



Safety Precautions

These precautions are important for safe usage. Be sure to follow them and use the product correctly.

Symbols and Meanings

	WARNING	May result in death or serious injury.
	CAUTION	May result in injury or property damage.

The following symbols are used to indicate important safety instructions for the use of the product.

Symbol	Meaning
	This symbol indicates a prohibited use of the product.
	This symbol is used to indicate a required step in the use of this product.

(Asia, Oceania, Middle East)

- This product is classified as Class 1 Equipment and must be grounded.
- Install this equipment where the electrical outlet is accessible.
- This appliance is not intended for use by persons (including children) with reduced physical, sensory or mental capabilities, or lack of experience and knowledge, unless they have been given supervision or instruction concerning use of the appliance by a person responsible for their safety.
Children should be supervised to ensure that they do not play with the appliance.
- Use the new hose set included with this equipment. Do not reuse an old hose set.

WARNING

	Do not plug or unplug the power plug with wet hands.
	• Doing so may cause electrical shock.
	Do not get any water or cleaning solution on the top unit or power plug.
	• Doing so may cause fire, electrical shock, heat or short circuit. • Doing so may cause the product to crack resulting in injury or water damage.
	Never disassemble, repair or alter.
	• Doing so may cause fire, electrical shock, heat or short circuit.
	Do not install the product on moving vehicles such as wheeled vehicles or boats.
	• Doing so may cause fire, electric shock, short circuit or malfunction. • The toilet seat, toilet lid, top unit or other parts may come loose and fall off, resulting in injury.

WARNING

Do not use the NEOREST if a malfunction occurs.

Always unplug the plug from the outlet.

Switch the breaker on the distribution board to OFF. (Asia, Oceania, Middle East)

- Close the water shutoff valve to stop water supply.

Possible malfunctions:

- Water is leaking from a pipe or the top unit.
- The product is cracked or broken.
- The product makes a strange noise or emits a strange odor.
- The product emits smoke.
- The product is abnormally hot.
- The bowl unit is clogged.
- The toilet seat cushion is out of place.

- Continued use after malfunction could cause a fire, electric shock, heat, short circuit, injury or water damage.

Only use tap water or potable well water (underground water).

Do not use seawater.

- Doing so may cause irritation to the skin and malfunction.

Do not touch the power plug during thunderstorms.

- Doing so may cause electrical shock.

Do not allow the water supply hose to touch the power plug or outlet.

- Doing so may cause condensation resulting in a fire, electrical shock, heat or a short.

Do not do anything that may damage the power cord, power plug.

Do not strike, yank, twist, excessively bend, damage, alter, or heat the electrical cords. Also, do not place anything heavy on, bind or pinch the electrical cords.

- Using a damaged electrical cord may result in a fire, electrical shock, heat or short.

Do not use a loose or faulty electrical outlet.

- Doing so may cause fire or short circuit.

Do not use any outlet or wiring equipment beyond its specified rating.

- Plugging too many plugs into the same outlet, for example using outlet splitters, can cause fire due to heat.

Do not use any power supply other than the one specified.

AC 120V, 60Hz

AC 220V-240, 50Hz / 60Hz (Asia, Oceania, Middle East)

- Doing so may cause fire or excessive heat.

Do not stick a finger or anything else into the warm air outlet.

Do not place anything on the warm air outlet or drape clothes over it.

- Doing so may cause burns, electrical shock or malfunction.

Keep cigarettes and other open flames away from the product.

- Failure to do so may cause fire.

Safety Precautions (Continued)

WARNING

Beware of irritation or burn.

- Improper use of the toilet seat may cause irritation or burn.
 - When sitting for a long time on the toilet seat, switch the toilet seat temperature adjustment to "OFF".
 - When any of the following persons use a heated seat or warm air drying, someone should switch the toilet seat temperature adjustment to "OFF" and switch the drying air temperature to "Low".
 - Young children, the aged and other users unable to set the temperature appropriately themselves
 - The ill, physically disabled and others who do not have freedom of movement.
 - Those using any medicines that cause drowsiness (sleeping or cold medicine), those who have been drinking heavily, anyone severely fatigued and anyone else liable to fall asleep.

This is an electrical product. Do not install it anywhere water is likely to get on the product or anywhere with humidity high enough that water is likely to form on the surface of this product. When using the product in a bathroom, install a fan or ventilation port and ensure good air flow through the bathroom.

- Failure to do so may cause fire or electrical shock.

Always connect the NEOREST to the cold water supply.

- Connecting to hot water supply may result in burns and equipment damage.

Check that an appropriate ground is installed. (Asia, Oceania, Middle East)

- If the ground is not installed, if there is a breakdown or electrical current leak, the lack of a ground could cause electrical shock.
 - For the ground, use copper wire with a ground resistance of 100 Ω max. and a diameter of 0.06in (1.6mm) min.
 - * If there is no ground installed, ask the contractor who did the installation to install the ground.

Make sure that a properly grounded (3 prong) outlet has been installed.

- Failure to install a grounded outlet could cause electrical shock in the event of a malfunction or short circuit.

Check that the outlet for electrical power is as follows. (Asia, Oceania, Middle East)

- Failure to do so may cause fire or electrical shock.
 - a. Protect the outlet circuits with a high-sensitivity quick leakage switch (with a rated current sensitivity of 15mA or less) or an insulating transformer (1.5kVA min., 3kVA max.).
 - b. Install the outlet and plug positioned at least 2.62 ft (0.8 m) above the floor and as far as possible from the bathtub.- * Check that the wiring in a. and b. above is complete. If the wiring has not been completed, ask the contractor who did the installation to do it.

Insert the power plug securely into the outlet. (North, Central, South America)

- Failure to do so may cause fire, heat or short circuit.

Check that the power plug is waterproofed with silicone rubber. (Asia, Oceania, Middle East)

- A power plug that is not water-proofed may cause fire and electrical shock.
 - * If the power plug is not water-proofed, ask the contractor who did the installation to water-proof it.

To unplug, hold the plug, not the cord.

- Do not unplug by pulling the cord.
- Pulling on the cord may cause damage and result in fire or heat.

If the electric cord is damaged, avoid danger by having the manufacturer's repair department or equivalent specialist replace it.

Always disconnect the power plug from the outlet before cleaning, maintenance or inspection.

Always switch the breaker on the distribution board to OFF. (Asia, Oceania, Middle East)

- Failure to do so may cause electrical shock or malfunction.
 - * Except when using "Wand cleaning" or "Bowl unit cleaning".

Periodically remove dust and dirt from the electrical plug and make sure it is securely plugged into the wall outlet. (North, Central, South America)

- Failure to do so may cause fire, heat or short circuit.
 - Pull the plug out from the outlet and wipe clean with a dry cloth.

CAUTION

Do not use the product if the top unit is unstable.

- Doing so may cause the top unit to come loose and fall, resulting in injury.

If the product is damaged, do not touch the damaged section.

- Doing so may cause electrical shock or injury.
 - Replace it immediately.

Do not apply strong force, mechanical shock, step on or stand on the toilet seat, toilet lid or top unit. Also do not place any heavy object on the toilet seat, toilet lid or top unit.

- Doing so could cause cracking or cause the top unit to come loose and fall resulting in injury.
- Doing so could damage the product and cause injury or water damage.

Do not lift up this product by the toilet seat or lid.

Do not raise the toilet seat or lid while objects are resting on top of the toilet.

- Doing so could cause the top unit to come loose and fall resulting in injury.

When cleaning or maintaining the plastic parts (top unit etc.) or the water supply hose, use a kitchen cleaner diluted with water. Do not use any of the following.

Toilet cleaner, household cleaner, benzene, paint thinner, powdered cleanser or nylon scrubbing pads.

- These items may damage or crack the plastic and cause injury or malfunction.
- These items could damage the water supply hose and cause a water leak.

To prevent a sudden water leak, do not remove the water filter drain valve when the shutoff valve is open.

- Doing so will cause water to spurt out.
 - (Refer to Page 33 for instructions on cleaning the water filter drain valve.)

Do not fold or crush the water supply hose; do not damage by cutting with a sharp object.

- Doing so may cause water leaks.

Do not pour hot water into the toilet.

- Doing so may result in damage to the toilet, injury or water damage.

Do not flush anything other than bodily waste and toilet paper. Also, do not flush too much toilet paper.

- Doing so may clog the toilet, causing waste water overflow and water damage.

Do not look directly at UV light.

- May cause eye or skin irritation.
- There are no user replaceable parts. Shall be serviced by qualified personnel only.



Safety Precautions (Continued)

CAUTION

If a water leak should occur, always close the shutoff valve.

When the ambient temperature is likely to drop to 0°C or lower, prevent damage to the pipes and hoses due to freezing.

- Frozen water pipes could cause the top unit and the pipes to break, resulting in a water leak.
- Regulate the room temperature to prevent the pipes and hoses from freezing during cold months.

When not using the NEOREST over an extended period of time, drain the water out of the top unit and the water supply hose, and pull the electrical plug from the outlet.

Switch the breaker on the distribution board to OFF. (Asia, Oceania, Middle East)

When using the product again, allow the product to refill with water first.

- Otherwise, the water in the tank might become contaminated and cause skin inflammation or other problems.
- Leaving the power on may cause fire or heat.

When installing the water filter drain valve, make sure that it is securely tightened in its proper position.

- Failure to securely tighten it may cause a water leak.

If the bowl unit is clogged, disconnect the power plug and remove the clog.

Switch the breaker on the distribution board to OFF and remove the clog.

(Asia, Oceania, Middle East)

- If the auto flush were allowed to function, it would make the wastewater in the bowl unit overflow and may result in water damage.
- Use any commonly available toilet plunger to remove the clogging.

Always flush, even after just urinating.

- Failure to do so may cause inadequate flushing or clogging of the bowl unit, resulting in waste water overflow and water damage.

Wipe condensation on the bowl unit, tank, water supply pipe and shutoff valve with a dry cloth.

- Condensation may cause staining and corrosion of the floor.
- Ventilate the restroom to prevent condensation.

Wipe any urine, condensation, cleaner, water, etc. that has gotten on the floor with a well-wrung mop or cloth.

- Failure to do so may cause staining and corrosion of the floor.

DANGER To reduce the risk of electrocution:

1. Do not use while bathing.
2. Do not place or store the product where it can fall or be pulled into a tub or sink.
3. Do not place in or drop into water or other liquid.
4. Do not reach for the product when it has fallen into water. Unplug it immediately.

WARNING To reduce the risk of burns, electrocution, fire or injury to persons:

1. Close supervision is necessary when this product is used by, on, or near children or invalids.
2. Use this product only for its intended use as described in this manual. Do not use attachments not recommended by the manufacturer.
3. Never operate this product if it has a damaged cord or plug, is not working properly, has been dropped or damaged, or has been dropped in water. Return the product to a service center for examination and repair.
4. Keep the cord away from heated surfaces.
5. Never block the air openings on the product or place it on a soft surface, such as a bed or couch, where the air openings may be blocked. Keep the air openings free of lint, hair, and other similar items.
6. Never use while sleepy or drowsy.
7. Never drop or insert any object into any opening or hose.
8. Do not use outdoors. Do not operate where aerosol (spray) products are being used or where oxygen is being administered.
9. Connect this product to a properly grounded outlet only.
See "Grounding Instructions" in Page 10.
10. The tank should be filled with water only.

Safety Precautions (Continued)

Grounding Instructions

This product should be grounded. In the event of an electrical short circuit, grounding reduces the risk of electric shock by providing an escape wire for the electrical current.

The plug must be plugged into an outlet that is properly installed and grounded.

⚠ DANGER - Improper use of the grounding plug can result in a risk of electric shock.

If repair or replacement of the cord or plug is necessary, do not connect the grounding wire to either flat-head terminal.

Check with a qualified electrician or serviceman if the grounding wire instructions are not completely understood, or if in doubt as to whether the product is properly grounded.

This product is factory equipped with a specific electric cord and plug to permit connection to a proper electric circuit. Make sure that the product is connected to an outlet having the same configuration as the plug.

No adapter should be used with this product. Do not modify the plug provided - if it will not fit in the outlet, have the proper outlet installed by a qualified electrician.

If the product must be reconnected for use on a different type of electric circuit, the reconnection should be made by qualified service personnel.

If it is necessary to use an extension cord, use only a three wire extension cord that has a three blade grounding plug, and a three-slot receptacle outlet that will accept the plug on the product.

Replace or repair a damaged cord.

For Asia, Oceania, Middle East

Confirm that the earthing wire is securely connected.

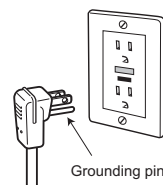

Save these instructions.

Operational Precautions

■ For prevention of malfunctions

- Do not block the body sensor or the remote control transmitter or receiver.

< About the body sensors >

Two types of body sensors are used.

- Body sensor A detects changes in heat.
 - Detection may be difficult when the room temperature exceeds 30°C, such as in the summertime.
 - When sunlight is directly on the sensor area or a heater is used in the bathroom, the sensor may detect incorrectly due to the heat, resulting in the automatic operation of functions such as auto lid opening and closing.
 - When the bathroom door is open, the sensor may detect people who pass to the front or side of the toilet.
 - Body sensor B detects when someone stands in front of the toilet bowl.
 - Body sensor B emits an infrared beam as shown in the figure. When a person moves into the range of this infrared beam, the sensor detects the person.
- *Detection by the sensor may be difficult when the toilet is used by someone small, such as a child.

Body sensor A



Body sensor B



< About the seat switch >

- When you sit on the toilet seat, the seat switch turns ON, enabling you to use various features. (A click sound is heard when the seat switch is ACTIVATED.)

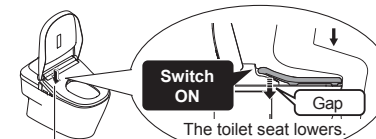

Seat switch (Built-in)

- Sit back on the toilet seat.
 - The seat switch will not turn on unless you sit on the seat properly.



Note

- When a child uses the NEOREST, the seat switch may not be ACTIVATED by their light body weight.
- Since the toilet seat is designed to move up and down, a clearance is provided between the toilet seat cushion and the toilet bowl.

■ For prevention of damage

- Wipe plastic areas such as the top unit and remote control with a soft, wet cloth.
- Do not lean against the toilet lid.



■ Problem Prevention

- Disconnect the power plug if there is a risk of lightning. Switch the breaker on the distribution board to OFF. (Asia, Oceania, Middle East)
- A toilet seat cover or a toilet lid cover cannot be used. (The body sensors or seat switch may not function properly.)



- Do not urinate on the top unit, toilet seat or wand. (Doing so may cause pink or brown stains or a malfunction.)
- Do not apply strong forces to the control panel of the remote control.
- When using a toilet cleaner to clean the toilet, wash it off within 3 minutes and leave the toilet seat and toilet lid open. Wipe off any cleaner that remains on the toilet bowl. (If vapor from a toilet bowl cleaner enters the top unit, it may cause a malfunction.)
- Do not expose to direct sunlight. (Doing so may cause changes in color, irregular heated seat temperature, remote control malfunction or NEOREST malfunction due to the change in temperature.)
- Use radios, etc. away from the NEOREST. (The NEOREST could cause interference with the radio signal.)
- If you use a booster seat for infants or a soft highchair, remove it after use. (Keeping it installed may prevent some of the functions from being used.)
- Do not apply force to the remote control. (May cause malfunction.) To prevent the remote control from being dropped, set it in the hanger when you are not using it. Be careful not to expose it to water.

About rear cleansing, rear soft cleansing, front cleansing and wide front cleansing

- These functions wash away waste and dirt from a localized area of your body.
- Do not cleanse too much or for too long. Doing so may wash away normal bacteria, upsetting the balance of bacteria inside your body.
- People who are receiving medical treatment or therapy in this localized area should consult their doctor before use.

Parts Names

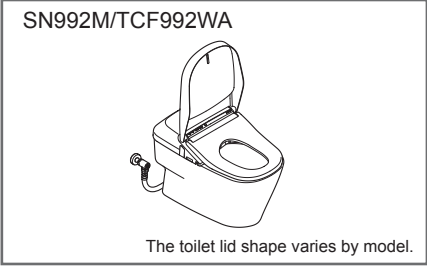
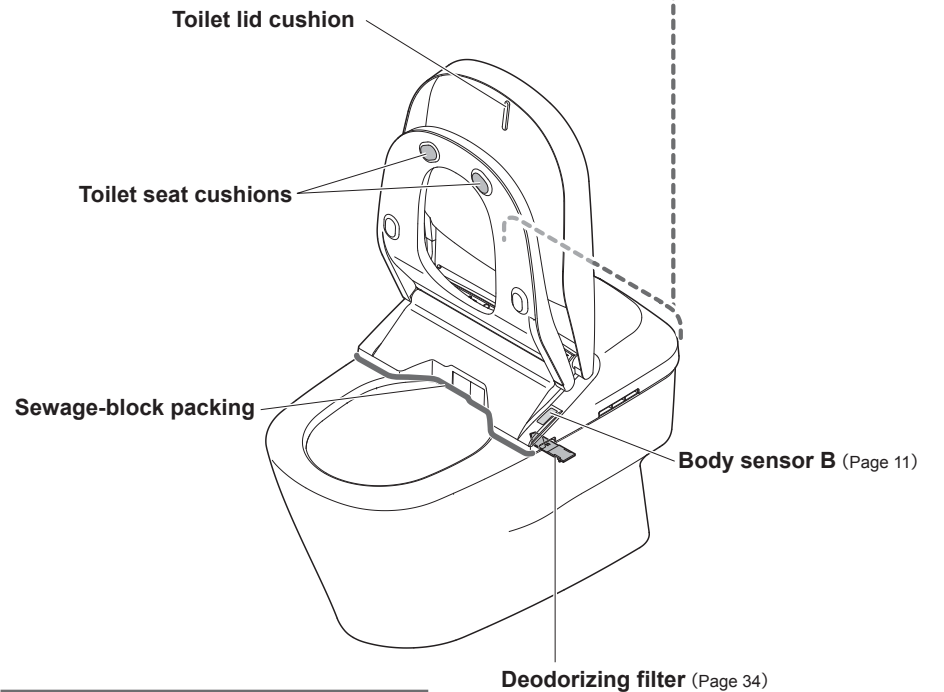
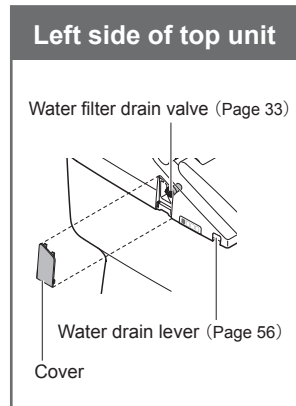
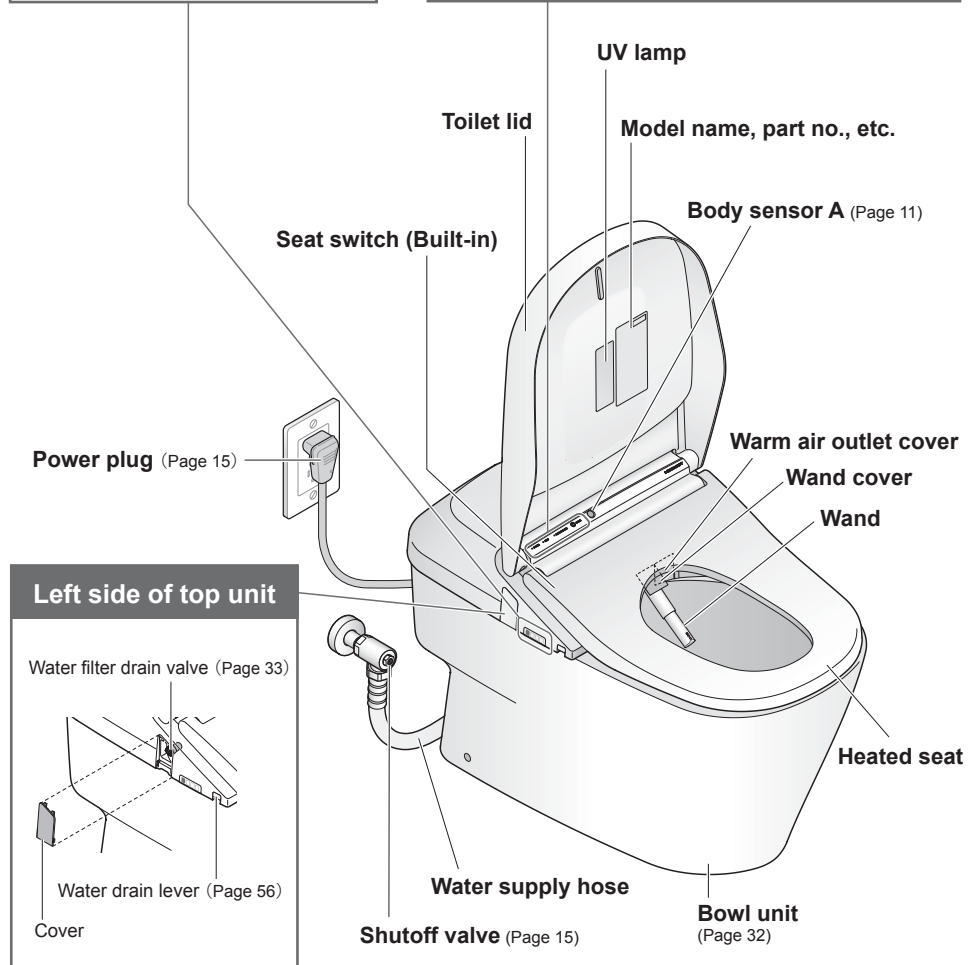
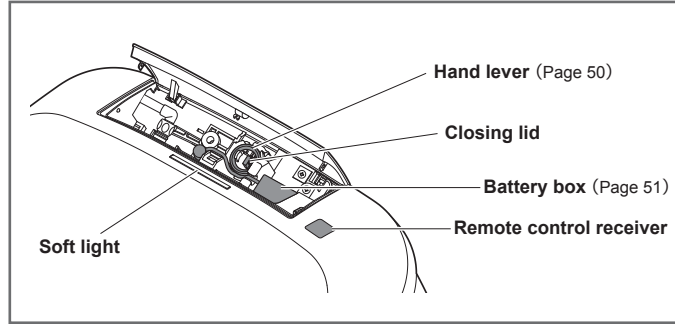
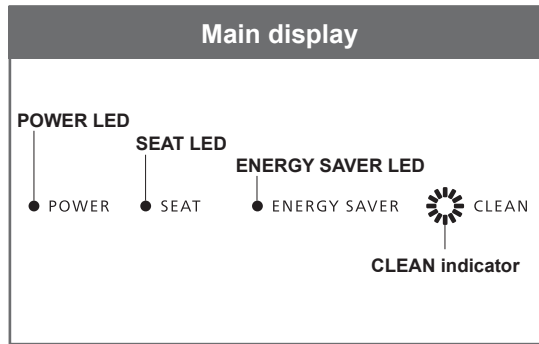
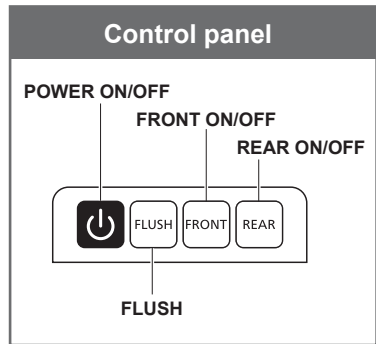

Descriptions in this manual are based on the illustrations of SN993MX / TCF993WA.

Preparation Using the Product for the First Time



1. Insert the battery

- 1 Remove the remote control from the hanger.

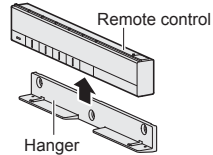

- 2 Open the battery cover and insert two AA batteries.

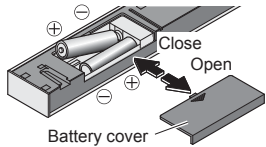

- When batteries are properly inserted, temperature levels appear on the display of the remote control (back side).
- The display goes out when no button on the remote control is pressed for 1 minute or more.

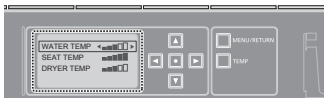

- 3 Mount the remote control in the hanger.

■ About the batteries

- Use dry cell, alkaline batteries. Follow the instructions below to prevent the batteries from rupturing or leaking fluid.
- When replacing the batteries, use new batteries of the same brand.
- If you will not be using the remote control for a long time, remove the batteries.
- Do not use rechargeable batteries.

If the remote control is secured (for anti theft)

- 1 Remove the screws (2, left and right) from the remote control fixture.

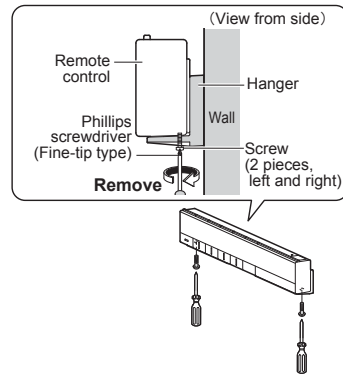

- 2 Remove the remote control from the hanger.

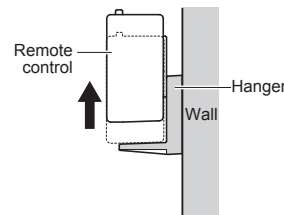

- To secure the remote control again
Tighten and fix the screws (2, left and right).
(Overtightening may cause damage to parts such as the hanger)

2. Turn on the power

- 1 Insert the power plug. Switch the breaker on the distribution board to ON.

(Asia, Oceania, Middle East)

- The wand extends and then retracts.

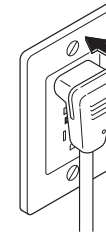

- 2 Check that the POWER LED on the main display is lit up. If it does not light up, press [POWER ON/OFF] to light it up.

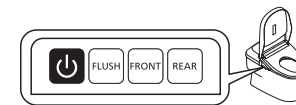

To turn the power "OFF"

- Press [POWER ON/OFF] to turn the power off.

- The POWER LED goes off.

3. Open the shutoff valve

- 1 Fully open the shutoff valve.

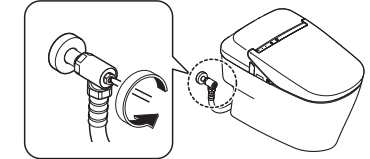

Basic Operations

Press a button on the remote control; a beep sounds when the top unit receives the signal.

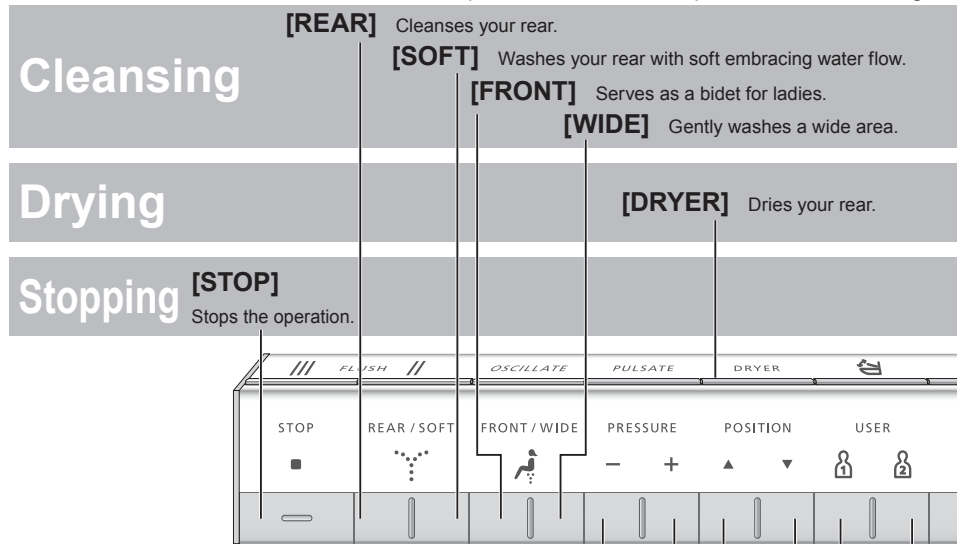

When flushing and opening/closing the toilet lid and toilet seat with the remote control

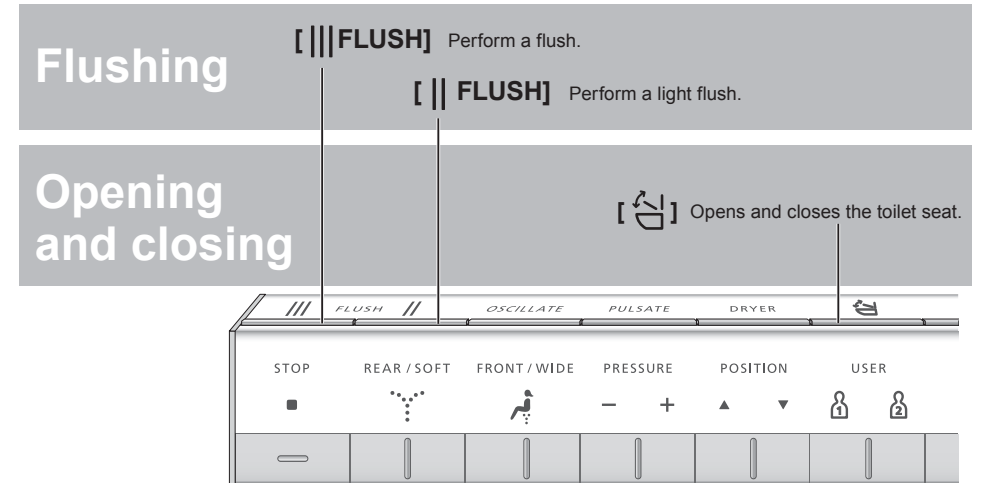

[PRESSURE]

- You can adjust the water pressure to one of five levels. ("-": Softer, "+": Stronger)
- When you press the button to flush, the position returns to the standard position(3rd position).
- If you do not want to return the wand to the standard position. (Page 48)

[OSCILLATE]

- The wand moves back and forth to wash your rear thoroughly.
- The setting changes between "ON" and "OFF" each time the button is pressed.

[PULSATE]

- Washes with the water pressure pulsating between soft and strong.
- The setting changes between "ON" and "OFF" each time the button is pressed.

[POSITION]

- You can adjust the position to one of five positions. (▲) to the front, (▼) to the rear
- When you press the button to flush, the position returns to the standard position (3rd position).
- If you do not want to return the wand to the standard position.(Page 48)

Note

- Functions that operate when a button is pressed during "REAR", "SOFT", "FRONT", or "WIDE" cleansing.
- Sitting back on the toilet seat makes it easier to adjust the wand position and to reduce splashing.

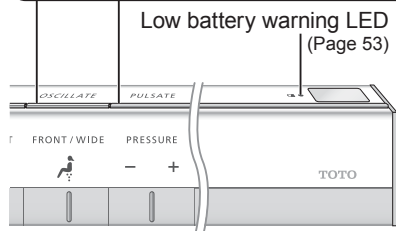

PERSONAL SETTING

[USER1] / [USER2]

You can store your preferred wand position, water pressure and water temperature a setting.

- To store a setting

While cleansing is in progress, set your preferred wand position, water pressure, and warm water temperature, and then press and hold [USER 1] or [USER 2] for 2 seconds or longer.

- To use

Press [USER 1] or [USER 2], and then press the button for the cleansing you want to use.

Remote control back side

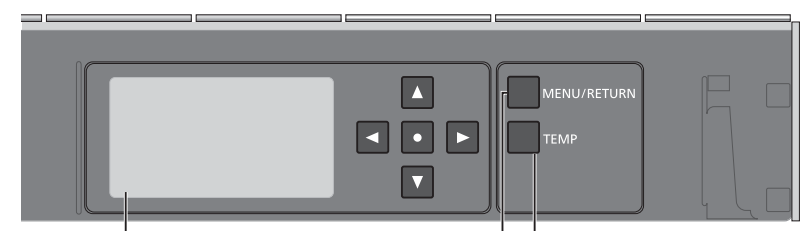

MENU/RETURN button

- Adjust settings
- Return to previous menu

Display screen

- Adjust settings, check status, etc.
- The display goes out when no button on the remote control is pressed for 1 minute or more.

Temperature adjustment button

- Adjust temperatures

Basic Operations About the Menu Screen

Set up easily with simple steps!

This section is an overview of the settings that can be configured with the remote control.

● See the corresponding pages for the detailed descriptions.

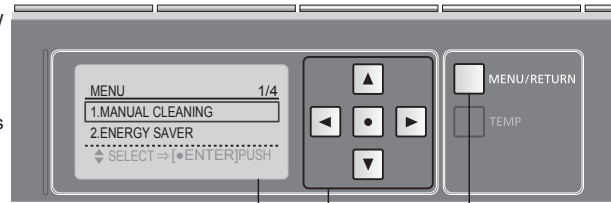

MENU/RETURN button

▲ ▼ : Select an item

◀ ▶ : Select a setting

● : Confirm

Number of items on display

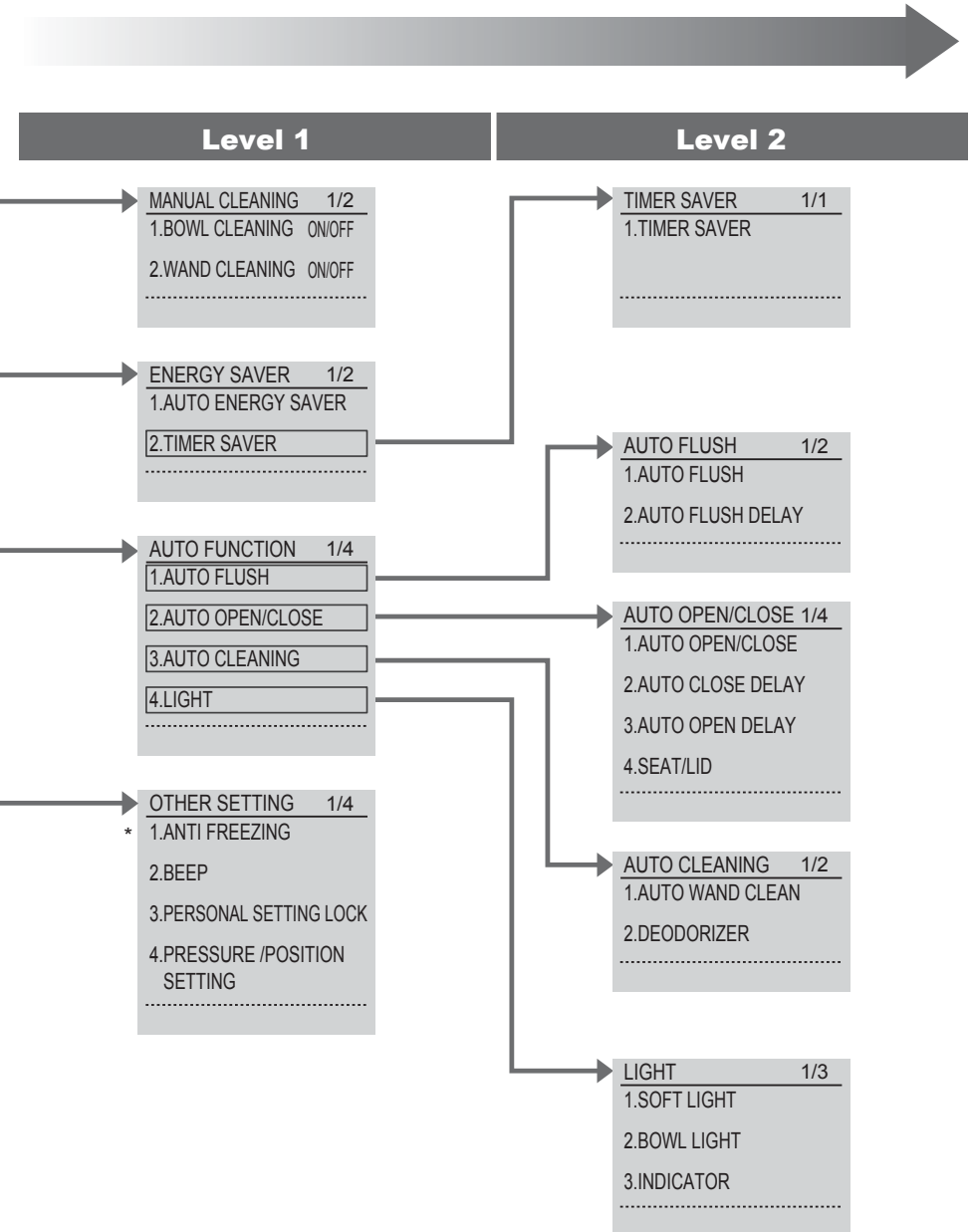
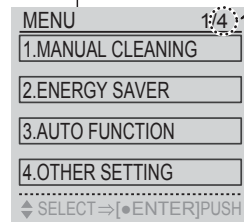

* With the SN993MX/992M, the display appears but settings cannot be made.

Automatic Functions

Cleaning Features

"ewater+" *1 is used automatically to clean the wand and bowl unit.

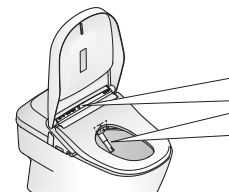

Support Cleaning

■ CLEAN indicator

Lights to show that the "clean" functions are operating.









■ Bowl light

Lights to show that auto bowl cleaning and auto wand cleaning are operating.

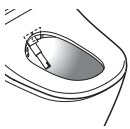

■ Note

■ Changing settings

DEODORIZER	 Starts the deodorizer →It stops after about 2 minutes	Deodorizer stops →It stops after about 2 minutes	<ul style="list-style-type: none"> • DEODORIZER ON/OFF (Page 44)
Clean the wand automatically with "ewater+" *1 AUTO WAND CLEANING		 Cleans the wand automatically *2 →The wand extends and "ewater+" *1 comes out from the base of the wand (Only when the cleansing functions are used)	<ul style="list-style-type: none"> • Waiting time before cleaning the wand after standing up SN993MX / TCF993WA: About 70 seconds SN992M / TCF992WA: About 25 seconds • When the cleansing functions have not been used in 8 hours, the wand is cleaned automatically. (Water comes out from near the wand cover.) <ul style="list-style-type: none"> • AUTO WAND CLEAN ON/OFF (Page 44)
PHOTOCATALYST CLEANING SN993MX/TCF993WA only	Pre-mist (A mist is sprayed inside the bowl unit to make it more difficult for dirt to adhere)	 After-mist →"ewater+" *1 mist is sprayed on the toilet bowl	The UV lamp lights up (For about 1 hour)
Sanitize the bowl unit with "ewater+" *1 AUTO BOWL CLEANING			<ul style="list-style-type: none"> • Waiting time before starting after-mist after standing up SN993MX/TCF993WA: About 125 seconds SN992M/TCF992WA: After auto wand cleaning • The following functions do not work when the toilet seat is open. SN993MX/TCF993WA: Pre-mist SN992M/TCF992WA: Pre-mist, after-mist • After pre-mist, water comes out from around the wand for a few seconds. • The pre-mist does not work for about 90 sec. after some one has used it. • When the cleansing feature is not used for about 8 hours, mist is sprayed on the toilet bowl automatically. • The UV lamp does not light up in the following conditions. →The toilet lid is open (such as when AUTO OPEN/CLOSE is set to "OFF") →"Flush" and cleansing *3 are not used • When the "Flush" and cleansing *3 are not used for about 10 hours, the UV lamp lights up.
BOWL LIGHT	 (Lights up during pre-mist)	 (Lights up during auto wand cleaning and after-mist)	<ul style="list-style-type: none"> • BOWL LIGHT ON/OFF (Page 46)
INDICATOR	 (Lights up)	 (Lights up in a cycle)	<ul style="list-style-type: none"> • Lights up continuously or in a cycle when "Auto wand cleaning", "Auto bowl cleaning" or "Deodorizer" is operating. (Lights up in a cycle only when the seat has been used.) <ul style="list-style-type: none"> • INDICATOR ON/OFF (Page 46)

If dirt adheres...

■ If dirt adheres to the wand during use, you can extend the wand to clean it.
 ● Cleaning the wand (Page 35)

■ You can clean the toilet bowl with water flowing.
 ● Cleaning the bowl unit (Page 32)

*1 What is meant by "ewater+" ?

This water containing hypochlorous acid generated from chloride ions in tap water, is widely used for cleaning and disinfecting items such as food, utensils and baby bottles.

- Well water may not deliver the required effect. (Because the level of chloride ions is low.)
- Clean, sterile water helps to minimize dirty surfaces, but does not make cleaning unnecessary.
- The effect and duration vary depending on the usage environment and conditions.

Operation

*2 Water comes out from around the wand.

*3 "Flush", "REAR" and "SOFT" cleansing.

Automatic Functions

Convenience Features

Various automatic functions are available, such as a toilet lid that opens and closes automatically.

- Operation under the initial settings is described below.



Note

Changing settings

Flush automatically AUTO FLUSH	When using the toilet seat 	The toilet flushes. (After about 10 seconds)	<ul style="list-style-type: none"> • Auto flush is not available in the following cases. (Flush with the remote control.) →For about 60 seconds after flushing When a person sits on the toilet seat (or when a male user stands in front of the bowl unit for urinating) for about 6 seconds or less • The flushing varies depending on how long you sit on the toilet seat. About 6 to 30 seconds: "Light flush" About 30 seconds or more: "Flush" • When the tank is being replenished and an LED will flicker on the main display, you cannot flush the toilet. 	<ul style="list-style-type: none"> • AUTO FLUSH ON/OFF • AUTO FLUSH DELAY (5 seconds, 10 seconds or 15 seconds) (Page 40)
	When standing-up to urinate 	The toilet flushes. (Performs a "LIGHT FLUSH" about 3 seconds after the user has moved about 30 cm away from the toilet seat)		
Opening the toilet lid automatically AUTO OPEN/ CLOSE	When using the toilet seat Toilet lid opens	Toilet lid closes (About 90 seconds after you stand up from the toilet seat)	<ul style="list-style-type: none"> • Detection by the body sensor may be difficult when the room temperature exceeds 30°C. (Open by hands.) • When the toilet lid is closed with the remote control or by hand, it cannot open automatically for about 15 seconds. (Open and close manually.) • When you do not sit on the toilet seat, or when you sit on it or stand in front of the bowl unit briefly, it takes about 5 minutes before the lid close automatically. 	<ul style="list-style-type: none"> • AUTO OPEN/CLOSE ON/OFF • AUTO OPEN DELAY (15 seconds, 30 seconds or 90 seconds) • AUTO CLOSE DELAY (25 seconds or 90 seconds) • Automatically opening the toilet lid or both the toilet seat and toilet lid (Page 42)
	When standing-up to urinate Toilet lid opens *Open the toilet seat with the remote control.	The toilet lid and toilet seat close (About 90 seconds after the user has moved about 30cm away from the toilet seat.)		
Lighting up the inside of the bathroom with a soft light SOFT LIGHT	Lights up in high mode 	Lights up in high mode (About 90 seconds)	Lights up in low mode (Goes out after about 5 seconds.) 	<ul style="list-style-type: none"> • SOFT LIGHT ON/OFF (Page 46)

Temperature Adjustment Warm Water / Toilet Seat / Drying

You can adjust the temperature levels or turn the settings to "OFF".

- 1** Remove the remote control from the hanger.
If the remote control is locked to prevent theft (Page 14)

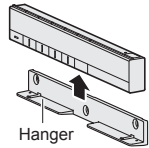

- 2** Press [TEMP].

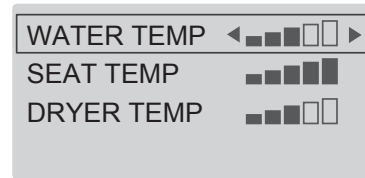

- 3** Use to select the item you want to set.

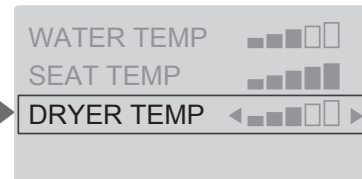
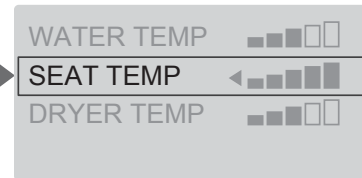
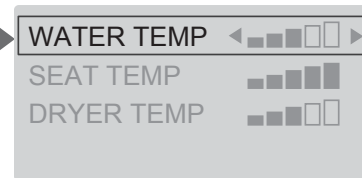

- 4** Use to select the <Settings complete> temperature level.

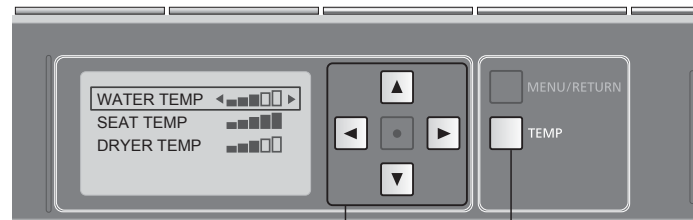
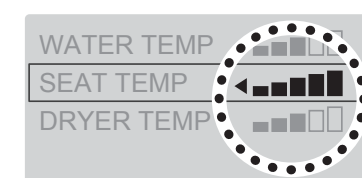

Remote control back side

Temperature adjustment button

- : Select an item
 : Select a setting

Warm water temperature

Press until "OFF" appears.

Toilet seat temperature

Press until "OFF" appears.

• When "OFF" is set, the SEAT LED will go off.

Drying air temperature

*To prevent condensation, the water temperature does not drop below 20°C even when set to "OFF".

Energy Saver Features Type

You can save energy by turning the toilet seat heater to a low temperature (or turning the heater "OFF") during periods when the toilet will be used infrequently.

• It takes about 10 days for the product to determine the periods when it is used relatively less frequently.

Type	Situation	When energy saver is set	When energy saver is in operation		AM 0 6 8 PM 5 9 0						
		Main Display		Toilet seat heater							
AUTO ENERGY SAVER	<p>You want to save energy but dislike a cold toilet seat</p> <p>The NEOREST detects time periods with infrequent use and lowers the toilet seat temperature automatically.</p>				Example: Used infrequently from 9 pm to 6 am 						
					Example: Set from 8 am to 5 pm 						
TIMER ENERGY SAVER	<p>You want to save energy only for the preset duration of time.</p> <p>If you set the duration of time (3 hours, 6 hours or 9 hours) during which you want to save energy, the heater automatically turns off every day in the set time slot.</p>				Example: When timer energy saver and auto energy saver are used together 						
AUTO ENERGY SAVER + TIMER ENERGY SAVER	<p>You want to save a lot of energy with auto energy saver and timer energy saver</p> <p>When both timer energy saver and auto energy saver are set, auto energy saver operates when timer energy saver is not operating.</p>			<ul style="list-style-type: none"> • During timer energy saver : Same LED indication as timer energy saver (See above) • During auto energy saver : Same LED indication as auto energy saver (See above) 		Example: When timer energy saver and auto energy saver are used together 					

Operation

Note

• Even if the toilet seat heater is set to "Low" or "OFF", the toilet seat is temporarily heated when you sit on it.

*1 The toilet seat temperature set on Page 24.

*2 The time period when the toilet seat heater is set to a low temperature by the auto energy saver.

*3 The time period when the toilet seat heater is "OFF".

To set energy saver ➔ Page 28 · 29

Energy Saver Features How to set

Set the timer energy saver at the time you want to start it.

1 MENU/RETURN
Press [MENU].

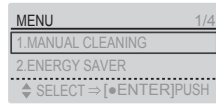

2
Use to select "ENERGY SAVER" and then press [ENTER].

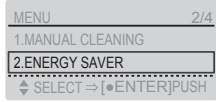

Remote control back side

MENU/RETURN button

: Select an item

: Select a setting

: Confirm



When energy saver is set, the ENERGY SAVER LED (green) lights up.



How to set

AUTO ENERGY SAVER

3
Use to select "AUTO ENERGY SAVER".

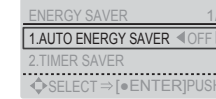

4
Use to select "ON" or "OFF" and then press [ENTER].

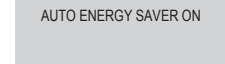
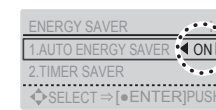

(To return → MENU/RETURN)

TIMER ENERGY SAVER

3
Use to select "TIMER SAVER" and then press [ENTER].

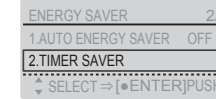

4
Use to select "3H", "6H", "9H" or "OFF" and then press [ENTER].

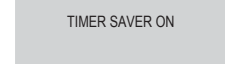

(To return → MENU/RETURN)

■ To change the timer energy saver time → Set the timer energy saver again at the time you want to start it.

TURNING OFF ENERGY SAVER

Select "OFF" in step 4 in each procedure above and then press [ENTER].

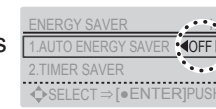

(Example)

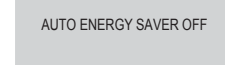

(To return → MENU/RETURN)

Maintenance

Power plug (Perform monthly) <North, Central, South America only>



Dry cloth



Wet cloth

- 1 Disconnect the power plug and wipe it with a dry cloth.



- 2 Insert the power plug.

WARNING

- Periodically remove dust from the blades and other parts of the power plug.
 - Disconnect the plug and wipe it with a dry cloth.



- Fully insert the power plug.
- When disconnecting, hold the main body of the power plug.
 - Pulling the cord may damage the plug or cord.

WARNING

- Always disconnect the power plug from the outlet before cleaning, maintenance or inspection. (Page 15)
- Always switch the breaker on the distribution board to OFF. (Asia, Oceania, Middle East only) (Otherwise, it may cause electrical shock or malfunction.)

***For safety, disconnect the power plug before cleaning or maintenance.**
***Switch the breaker on the distribution board to OFF.**
 (Asia, Oceania, Middle East only)

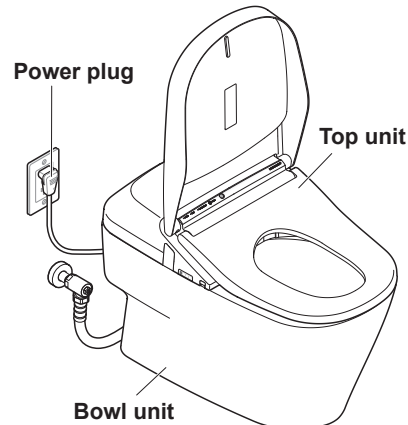

Do not use a dry cloth or toilet paper on plastic parts.
 (May cause damage.)

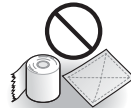

*Except when using "Wand cleaning" or "Bowl unit cleaning".
 *After the power plug is inserted (after the breaker on the distribution board is turned to "ON" (Asia, Oceania, Middle East)), the toilet lid does not open automatically for about 10 to 60 seconds. Open and close by hands (because the unit is in warm-up operation).

Cautions with use of detergent

- The NEOREST is an electric appliance. Be careful not to let water seep inside or leave detergent in the gap between the top unit and bowl unit. (May damage plastic parts or cause a malfunction.)
- When using a toilet cleaner to clean the toilet, wash it off within 3 minutes and leave the toilet seat and toilet lid open.
 - Wipe off any cleaner that remains on the toilet bowl. (If vapor from a toilet bowl cleaner enters the top unit, it may cause a malfunction.)
- Do not use any water repellent, stain-proofing cleaner or surface coating agent. These products would not damage the porcelain surface, but they may cover the porcelain surface and reduce the effect of the built-in stain prevention technology.

Top Unit (Perform daily)



Soft cloth soaked in water

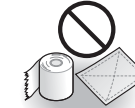

- Toilet paper
- Dry cloth
- Nylon scrubbing pads (May cause damage.)

- 1 Unplug the power plug. (Page 15)
Switch the breaker on the distribution board to OFF. (Asia, Oceania, Middle East)
- 2 Wipe with a soft cloth that has been soaked in water and wrung-out thoroughly.

For heavy dirt

- Wipe with a soft cloth soaked in diluted, neutral kitchen detergent, and then wipe with a soft cloth soaked in water.



Neutral kitchen detergent



- Paint thinner
- Benzene
- Powdered cleanser

- 3 Insert the power plug. (Page 15)
Switch the breaker on the distribution board to ON. (Asia, Oceania, Middle East)

Attention!

- Do not push or pull the wand cover or the warm air dryer cover with undue force. (May cause damage or malfunction.)

Maintenance

Bowl unit (Perform daily)



- Toilet brush
- Neutral toilet detergent



- Strongly acidic cleaners or strong alkaline cleaners
- Cleaners containing abrasive compounds
- Fluoride-based detergent (containing hydrogen fluoride or ammonium fluoride)
- Wire brush
- Abrasive nylon scrubbing brush

- 1 Unplug the power plug. (Page 15)
Switch the breaker on the distribution board to OFF. (Asia, Oceania, Middle East)

- 2 Clean with a toilet brush or a similar tool.
 - **The bowl unit can be cleaned while the toilet is flushing.**
Insert the power plug.
Switch the breaker on the distribution board to ON.
(Asia, Oceania, Middle East)

"BOWL CLEANING"

Operate with the buttons on the back side of the remote control.

- (1) Press [MENU].

- (2) Use to select "MANUAL CLEANING".

- Press [ENTER].

- (3) Use to select "BOWL CLEANING ON/OFF".

- Press [ENTER].

- The toilet flushes (for about 30 seconds).
- Clean inside the bowl unit.

- ↓
- The water in the bowl unit is drained and the water level drops (for about 30 seconds).

- ↓
- The water in the bowl unit is drained and the water returns to its original level.

- To stop part way through, Press [STOP].

■ If the bowl unit is clogged

- Using a manual pump or the like, provide 10 cm or more clearance between the top of the bowl unit and the water surface.
- Use commercially available tools that are made for unclogging the toilet bowl. (May cause overflow of dirty water and water damage.)

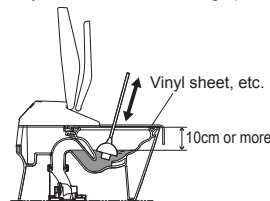

■ If the floor is dirty

- Clean it with a well wrung cloth. (Not cleaning the floor may cause stains or corrosion.)
- Using the product while standing may cause splashing. To reduce splashing, use the product while seated.

- 3 Insert the power plug. (Page 15)
Switch the breaker on the distribution board to ON. (Asia, Oceania, Middle East)

When the toilet bowl repels water or tends to get dirty (SN993MX/TCF993WA only)

● The toilet bowl surface needs to be cleaned.

→ Clean with a toilet brush or the like using commercially available hydrochloric acid-based or inorganic acid-based detergent.

- For daily cleaning, use neutral detergent.

● Cautions with use of detergent (Page 31)

Water Filter Drain Valve (Perform once every 6 months)

<If you think the water pressure has weakened>

- 1 Close the shutoff valve.
 - The water supply stops.

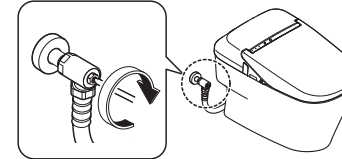

- 4 Remove the cover and water filter drain valve.
 - Loosen with a flat-head screwdriver and then pull.

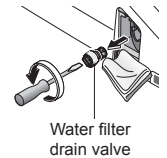
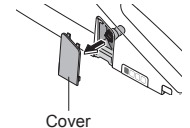

⚠ CAUTION

- Do not remove the water filter drain valve while the shutoff valve is open. (Otherwise, water may leak out)

- 2 Extend the wand.
 - Operate with the buttons on the back side of the remote control.

- (1) Press [MENU].

- (2) Use to select "MANUAL CLEANING".

- Press [ENTER].

- (3) Use to select "WAND CLEANING ON/OFF".

- Press [ENTER] to extend the wand.

- Press [ENTER] again to retract the wand.

(Release the pressure from the water supply pipe.)

- 3 Unplug the power plug. (Page 15)
Switch the breaker on the distribution board to OFF.
(Asia, Oceania, Middle East)

- 5 Clean with a tool such as a toothbrush.
 - Also, remove any dust from inside the hole of the water filter drain valve.

- 6 Reinstall the water filter drain valve and cover.
 - Insert the water filter drain valve and tighten it securely with a flat-head screwdriver.

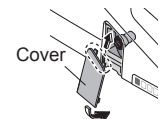

- 7 Insert the power plug. (Page 15)
Switch the breaker on the distribution board to ON.
(Asia, Oceania, Middle East)

- 8 Open the shutoff valve. (Page 15)

Maintenance

Deodorizing filter (Perform monthly)

<If you notice odors>

- 1** Unplug the power plug. (Page 15)
Switch the breaker on the distribution board to OFF. (Asia, Oceania, Middle East)

- 2** Remove the deodorizing filter.
 - Use the recess of the deodorizing filter to pull it out.
 - Do not pull with undue force. (May cause damage or malfunctions)

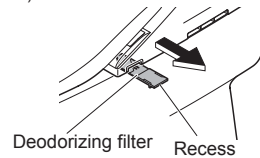

- 3** Clean with a tool such as a toothbrush.
 - When washing with water, dry off all water before mounting.

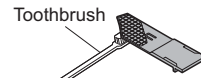

- 4** Mount the deodorizing filter.
 - Push firmly until a click sound is heard.

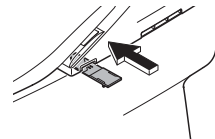

- 5** Insert the power plug. (Page 15)
Switch the breaker on the distribution board to ON. (Asia, Oceania, Middle East)

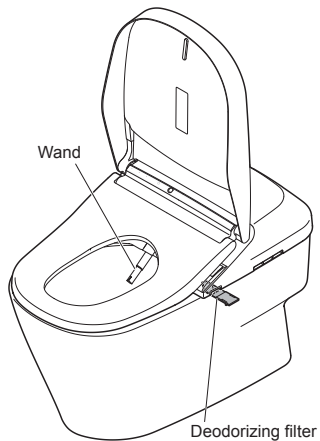

Wand (Perform monthly)

<Wand cleaning> If you notice dirt



Soft cloth soaked in water

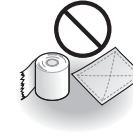

Toilet paper, etc.
(May cause damage.)

- 1** Extend the wand.
 - Operate with the buttons on the back side of the remote control.

(1) Press [MENU].

(2) Use to select "MANUAL CLEANING".

Press [ENTER].

(3) Use to select "WAND CLEANING ON/OFF".

Press [ENTER].

- The wand extends and water sprays out for cleaning.
- The wand automatically retracts after about 5 minutes.

- 2** Wipe with a soft, wet cloth.
 - Do not pull, push or press the wand with excessive force. (May cause damage or malfunction.)

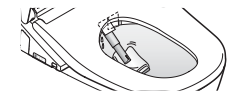

- 3** Press [STOP] on the front side of the remote control.
 - The wand retracts.

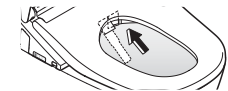

Maintenance

Water filter (Perform once every 6 months)

1 Close the shutoff valve.
(Page 57)

CAUTION

Do not remove the water filter drain valve while the shutoff valve is open.
(Otherwise, water may leak out)

2 Extend the wand.
• Operate with the buttons on the back side of the remote control.

- (1) Press [MENU].
- (2) Use to select "MANUAL CLEANING".
- Press [ENTER].
- (3) Use to select "WAND CLEANING ON/OFF".
- Press [ENTER] to extend the wand.
- Press [ENTER] again to retract the wand.

(Release the pressure from the water supply pipe.)

3 Unplug the power plug.
Switch the breaker on the distribution board to OFF.
(Asia, Oceania, Middle East)

4 Loosen the nut on the shutoff valve to remove the water filter.

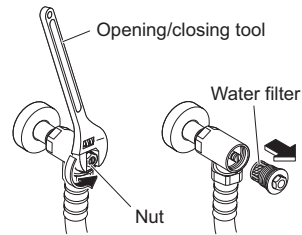

5 Remove the water filter and clean with a toothbrush or similar instrument.

- Do not use detergent
- Do not apply excessive force to the water filter (could cause deformation)
- Replace the filter when it is very dirty or clogged.

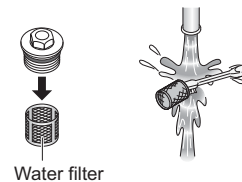

6 Insert the water filter into the nut and insert the nut into the shutoff valve.

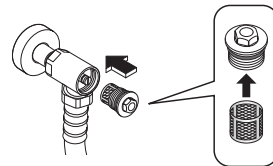

7 Tighten the nut on the shutoff valve.

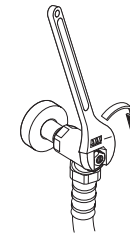

8 Open the shutoff valve. (Page 15)
• Check that there are no leaks in the shutoff valve or plumbing connections.

9 Insert the power plug.
Switch the breaker on the distribution board to ON.
(Asia, Oceania, Middle East)

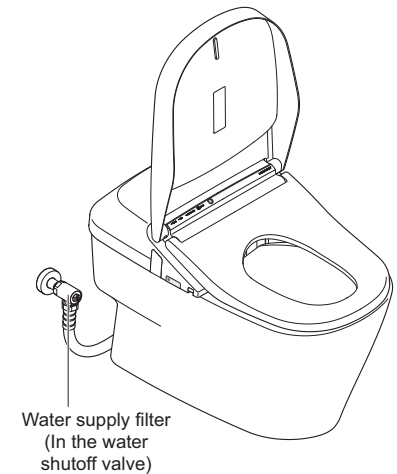

Changing Settings

Setting List



Remote control back side

		Setting Types	Available Settings*	Applicable Models	Setting Ref. Page	
AUTO FUNCTIONS	AUTO FLUSH	AUTO FLUSH	• Set whether or not to clean the bowl unit automatically	ON/OFF	All models	Page 40
		AUTO FLUSH DELAY	• Change the amount of time before the toilet flushes automatically	5S/10S/15S		
	AUTO OPEN/CLOSE	AUTO OPEN/CLOSE	• Set whether or not to open the toilet lid automatically	ON/OFF	All models	Page 42
		AUTO CLOSE DELAY	• Change the amount of time before the lid/seat closes automatically	25S/90S		
		AUTO OPEN DELAY	• Change the amount of time after which the lid/seat opens automatically upon closing it with hands	15S/30S/90S		
	AUTO CLEANING	SEAT/LID	• Automatically open and close the toilet lid/Automatically open and close the toilet seat and toilet lid	LID/SEAT·LID	All models	Page 44
		AUTO WAND CLEAN	• Set whether or not to clean the wand automatically	ON/OFF		
	LIGHT	DEODORIZER	• Set whether or not to deodorize automatically after sitting on the toilet seat	ON/OFF	All models	Page 46
		SOFT LIGHT	• Set whether or not to use the soft light	ON/OFF		
		BOWL LIGHT	• Set whether or not to use the light inside the bowl unit	ON/OFF		
OTHER SETTINGS	INDICATOR	• Set whether or not to light up the CLEAN indicator	ON/OFF	All models	Page 48	
	ANTI FREEZING	• Set whether or not to run the water for the bowl unit and wand automatically at a fixed interval in order to prevent freezing (dynamic mode Page 54)	ON/OFF			
	BEEP	• Set whether or not to make a beep sound	ON/OFF			
	PERSONAL SETTING LOCK	• Set whether or not to use the personal setting lock	ON/OFF			
	PRESSURE/POSITION SETTING	• Set whether or not to keep your favorite pressure and position settings	ON/OFF			

*The black text is the initial setting.

Changing Settings

AUTO FLUSH

1 MENU/RETURN
Press [MENU].

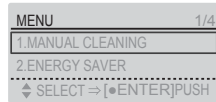

2
Use to select "AUTO FUNCTION" and then press .

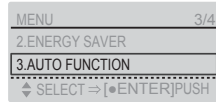

3
Use to select "AUTO FLUSH" and then press .

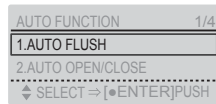

Set whether or not to clean the bowl unit automatically
AUTO FLUSH

4
Use to select "AUTO FLUSH".

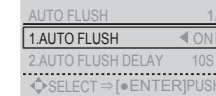

5
Use to select "ON/OFF" and then press .

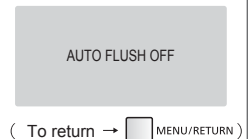
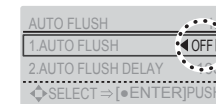

Select the amount of time (5 seconds, 10 seconds or 15 seconds) after which the toilet bowl flushes automatically
AUTO FLUSH DELAY*

4
Use to select "AUTO FLUSH DELAY".

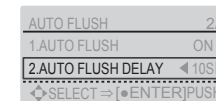

5
Use to select "5S", "10S" or "15S" and then press .

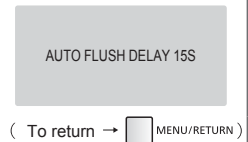
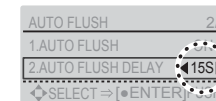

*This operation is not available when the AUTO FLUSH is "OFF".

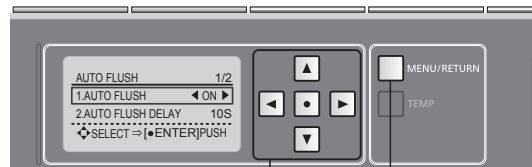

Remote control back side

MENU/RETURN button

: Select an item

: Select a setting

: Confirm

Items set on this display

1. AUTO FLUSH
2. AUTO FLUSH DELAY

Changing Settings

AUTO OPEN / CLOSE

1 MENU/RETURN
Press [MENU].

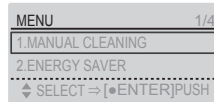

2

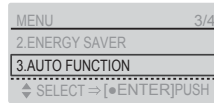

Use to select "AUTO FUNCTION" and then press .

3

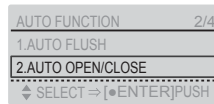

Use to select "AUTO OPEN/CLOSE" and then press .

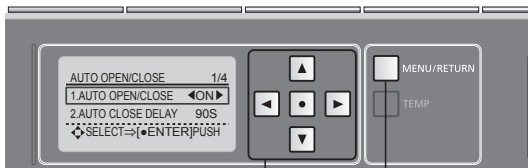

Remote control back side

MENU/RETURN button

: Select an item

: Select a setting

: Confirm

Items set on this display

1. AUTO OPEN/CLOSE
2. AUTO CLOSE DELAY
3. AUTO OPEN DELAY
4. SEAT/LID

Set whether or not to open the toilet lid automatically*1
AUTO OPEN/CLOSE

4 Use to select "AUTO OPEN/CLOSE".

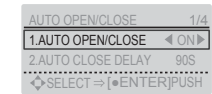

5 Use to select "ON/OFF" and then press .

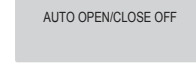
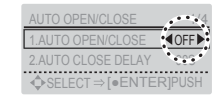

(To return → MENU/RETURN)

Change the time before the lid/seat closes automatically (25 SEC or 90 SEC)*3
AUTO CLOSE DELAY*2

4 Use to select "AUTO CLOSE DELAY".



5 Use to select "25S" or "90S" and then press .

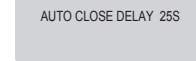
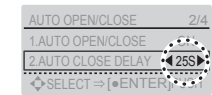

(To return → MENU/RETURN)

Change the time period till automatic opening (15 SEC, 30 SEC or 90 SEC) (After closing manually)
AUTO OPEN DELAY*2

4 Use to select "AUTO OPEN DELAY".



5 Use to select "15S", "30S" or "90S" and then press .

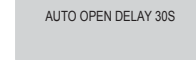
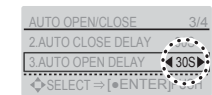

(To return → MENU/RETURN)

Automatically open and close the toilet lid only/ Automatically open and close the toilet seat and toilet lid*4
SEAT/LID*2

4 Use to select "SEAT/LID".

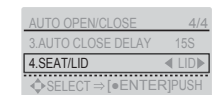

5 Use to select "LID" or "SEAT·LID" and then press .

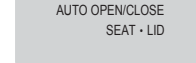
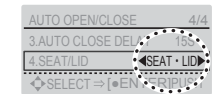

(To return → MENU/RETURN)

*1 When AUTO OPEN/CLOSE is set to "OFF", UV light does not work while the lid is open.

Please close with your hands. (SN993MX, TCF993WA only)

*2 This operation is not available when the AUTO OPEN/CLOSE is "OFF".

*3 When set to 25 seconds, the lid/seat does not open automatically for about 15 seconds after closing automatically.

*4 When the toilet seat and toilet lid are set to open automatically, pre-mist is not sprayed.

Changing Settings

AUTO CLEANING

1 MENU/RETURN
Press [MENU].

2
Use to select "AUTO FUNCTION" and then press [ENTER].

3
Use to select "AUTO CLEANING" and then press [ENTER].

Set whether or not to clean the wand automatically

AUTO WAND CLEAN

4 Use to select "AUTO WAND CLEAN".

5 Use to select "ON/OFF" and then press [ENTER].

4 Use to select "DEODORIZER".

5 Use to select "ON/OFF" and then press [ENTER].

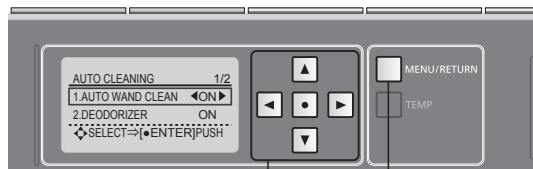

Remote control back side

MENU/RETURN button

- : Select an item
- : Select a setting
- : Confirm

Items set on this display

- 1. AUTO WAND CLEAN
- 2. DEODORIZER

Changing Settings

LIGHT

1 MENU/RETURN
Press [MENU].

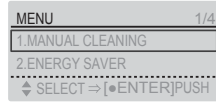

2
Use to select "AUTO FUNCTION" and then press [ENTER].

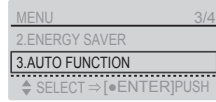

3
Use to select "LIGHT" and then press [ENTER].

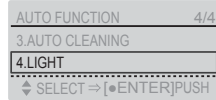

Remote control back side

MENU/RETURN button

- : Select an item
- : Select a setting
- : Confirm

Items set on this display

1. SOFT LIGHT
2. BOWL LIGHT
3. INDICATOR

Set whether or not to use the soft light SOFT LIGHT

4 Use to select "SOFT LIGHT".



5 Use to select "ON/OFF" and then press [ENTER].



SOFT LIGHT OFF

(To return → MENU/RETURN)

Set whether or not to use the light inside the bowl unit BOWL LIGHT

4 Use to select "BOWL LIGHT".

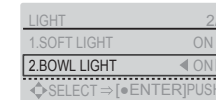

5 Use to select "ON/OFF" and then press [ENTER].

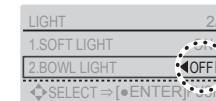

BOWL LIGHT OFF

(To return → MENU/RETURN)

Set whether or not to light up the CLEAN indicator INDICATOR

4 Use to select "INDICATOR".

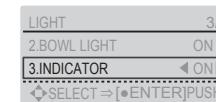

5 Use to select "ON/OFF" and then press [ENTER].

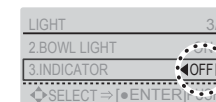

INDICATOR OFF

(To return → MENU/RETURN)

Changing Settings

OTHER SETTING

1 MENU/RETURN
Press [MENU].

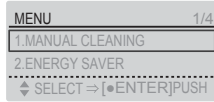

2
Use to select "OTHER SETTING" and then press .

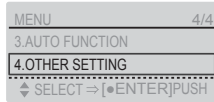

Remote control back side

MENU/RETURN button

: Select an item

: Select a setting

: Confirm

Items set on this display

- 1. ANTI FREEZING*
- 2. BEEP
- 3. PERSONAL SETTING LOCK
- 4. PRESSURE/POSITION SETTING

* With the SN993MX/992M, the display appears but settings cannot be made.

Set whether or not to run the water for the bowl unit and wand automatically at a fixed interval in order to prevent freezing

ANTI FREEZING (TCF993WA/992WA only)

3 Use to select "ANTI FREEZING".



4 Use to select "ON/OFF".
<For setting to "ON">When the time is set, the toilet bowl is cleaned in 10 minute intervals to prevent freezing.

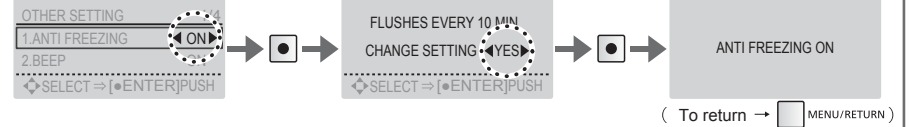

Set whether or not to make a beep sound

BEEP

3 Use to select "BEEP".



4 Use to select "ON/OFF" and then press .

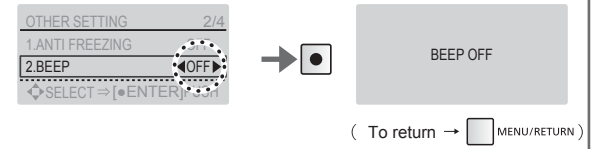

Set whether or not to use the personal setting lock

PERSONAL SETTING LOCK

3 Use to select "PERSONAL SETTING LOCK".

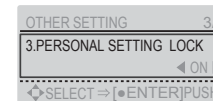

4 Use to select "ON/OFF" and then press .

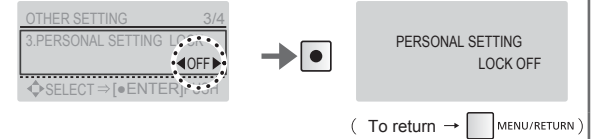

Set to keep your favorite pressure and position settings for future use

PRESSURE/ POSITION SETTING

3 Use to select "PRESSURE/ POSITION SETTING".

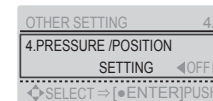

4 Use to select "ON/OFF" and then press .

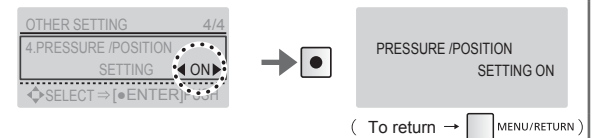

What to Do?

If the water does not flow due to a power failure (when water failure hasn't occurred)

■ You can clean the toilet bowl with the hand lever.

*If a power failure has not occurred, the hand lever will not flush the toilet bowl.

- 1 Open the cover located at the back of the top unit.

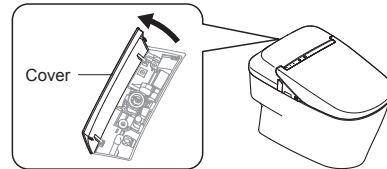

- 2 Dismount the hand lever from the plate and pull until it stops. (Hold about 30 sec.)

- The water in the toilet bowl rises.

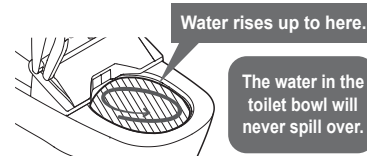
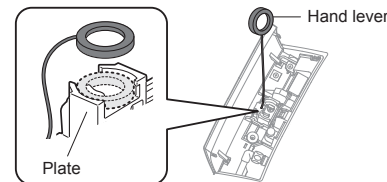

- 3 When an electronic "beep" is heard and water supply stops, loosen the hand lever.

- The toilet flushes.

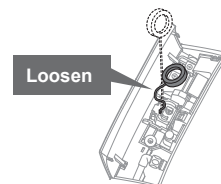

*If the hand lever is loosened after or while cleaning the toilet bowl, the toilet bowl will not flush for about 60 sec. Wait at least 60 sec. before cleaning the toilet bowl again.

- 4 Reinstall the hand lever of the toilet bowl cleaning lever on the plate, close the cover.

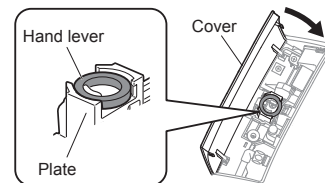

- When the water supply is restored, be sure to perform a flush. (To prevent waste from remaining in the drain pipe.)

- The toilet can also be flushed with a bucket of water during power failure. (Page 52)

If the power failure continues for a long period of time (2 days or longer)...

■ Insert the batteries into the battery box. (About the batteries, Page 14)

- 1 Take out the battery box, put the battery in it and reinstall the battery box. (Size AA battery: x 2)

- * We ask the customer to prepare the battery.
- * Check the polarity of the battery.

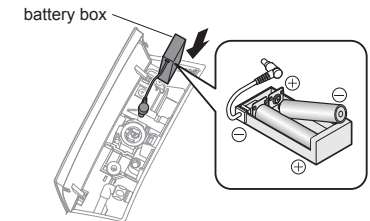

- 2 Dismount the hand lever and the closing lid in this order.

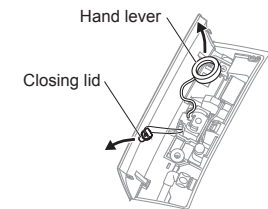

- 3 Insert the plug of the battery box into the plug receptacle.

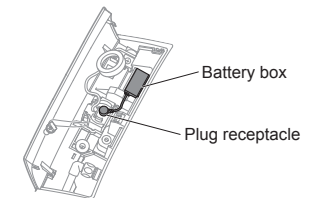

- 4 Clean the toilet bowl with the hand lever. (Step 2 to 3 on Page 50)

- 5 When the power recovers, pull out the battery box, take out the battery and then mount the battery box, the closing lid and the hand lever in their original positions.

If the unit is hard to operate, operate it after removing the cover.

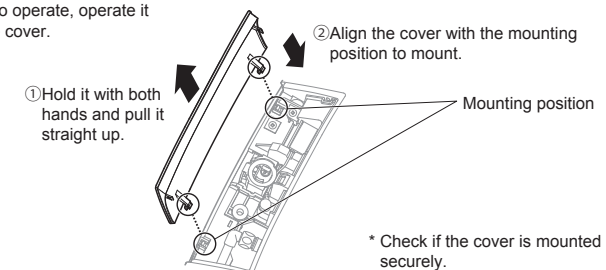

What to Do?

If the water does not flow due to a water service interruption

- 1 Use a bucket to flush water.
- 2 If the water level is low after flushing, add more water.
 - Prevents odors.

Attention!

- If there is a water supply failure, set the auto bowl unit cleaning to "OFF".
- When the water supply is restored, be sure to perform a flush. (To prevent waste from remaining in the drain pipe.)

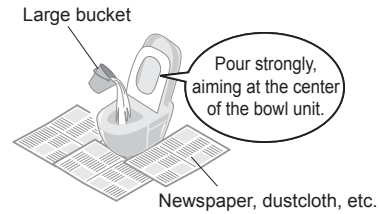

If you cannot operate with the remote control

■ Operation is also possible using the buttons on the control panel.

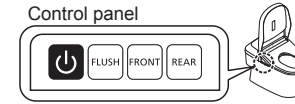

■ If the low battery warning LED is flashing, replace the batteries.

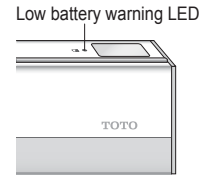

■ Replacing the batteries

- 1 Press [POWER ON/OFF] on the control panel.
The POWER LED goes off.
- 2 Remove the remote control from the hanger. (Page 14)
- 3 Open the cover and replace the AA batteries. (Page 14)
- 4 Mount the remote control in the hanger.
- 5 Press [POWER ON/OFF] on the control panel.
The POWER LED lights up.

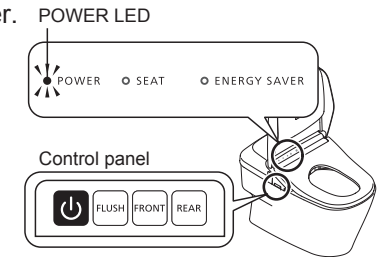

What to Do? Freeze Damage Prevention

When the ambient temperature is likely to drop to 0°C or lower, take measures to prevent freezing.

Attention!

- When the ambient temperature is likely to drop to 0°C or lower, do not use the energy saver feature. (May damage the product.)
- Warm the bathroom or take measures against freezing so that the ambient temperature does not drop below 0°C.
- Before starting work, set "AUTO FLUSH" (Page 40) and "AUTO OPEN/CLOSE" (Page 42) to "OFF".

Dynamic mode (TCF993WA/992WA only)

This method runs the water for the bowl unit and wand automatically at a fixed interval in order to prevent freezing.

How to Set (Page 48)

- Switch ANTI FREEZING to ON with the remote control.

While ANTI FREEZING is set to ON, it works as follows.

- The POWER LED flashes.
- The toilet flushes at intervals of about 10 minutes.
- About 50 ml of water comes out from near the wand at intervals of 5 minutes. (The wand remains retracted.)
- After-mist is sprayed at intervals of 5 minutes. (TCF993WA only)

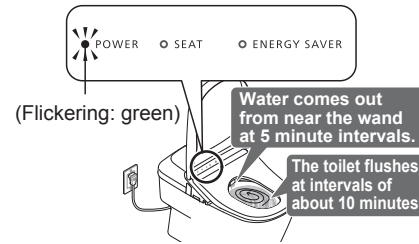

Freeze damage prevention

How to drain the water

1 Close the shutoff valve. (Page 57)

2 Drain the pipe.

(1) Extend the wand.

- Operate with the buttons on the back side of the remote control.

1. Press [MENU].

2. Use to select "MANUAL CLEANING".

Press [ENTER].

3. Use to select "WAND CLEANING ON/OFF".

Press [ENTER] to extend the wand.

Press [ENTER] again to retract the wand.
(Release the pressure from the water supply pipe.)

(2) Unplug the power plug. (Page 15)
Switch the breaker on the distribution board to OFF.
(Asia, Oceania, Middle East)

(3) Remove the cover and water filter drain valve.

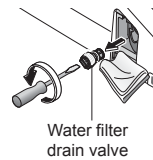
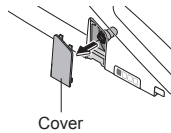

(4) After draining the water, install the water filter drain valve and cover.

- Insert the water filter drain valve and use a flat-head screwdriver to tighten it securely.

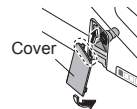

(5) Insert the power plug. (Page 15)
Switch the breaker on the distribution board to ON.
(Asia, Oceania, Middle East)

Freeze damage prevention (Continued)

3 Check that the POWER LED on the main display is lit up. (Page 15)

4 Set the toilet seat temperature to "High". (Page 24)

(To maintain the temperature.)

- When finished, close the toilet seat and toilet lid.

To use the NEOREST again

- The water needs to be replenished. (See below)

Resupplying the Water (After draining)

1 Open the shutoff valve.
Check that water is not leaking from a pipe or the top unit.

2 If the power is not turned ON insert it. (Page 15)
Switch the breaker on the distribution board to ON.
(Asia, Oceania, Middle East)

3 Discharge water from the wand.
(1) Pressing down the left side of the toilet seat,
(2) Press the "REAR" on the remote control to discharge water from the wand. (Catch the water in a paper cup or other receptacle)

If the remaining water has frozen and no water comes out

- Heat the inside of the bathroom, and warm the water supply hose and shutoff valve using a cloth soaked in warm water.

4 Press [FLUSH] on the remote control to flush.

• If there is no water in the tank, you cannot flush the toilet. Never operate the toilet with no water in the tank.

• When the tank is filling with water, the LED on the main display will flicker. After the tank is full, the LED changes. (Tank filling time: approx. 30 seconds)

5 After the bowl unit fills with water, press [FLUSH] again.

What to Do? Long Periods of Disuse

If the toilet is in a location you will not visit for a long time, drain the water.
(The water in the tank may become contaminated and cause skin irritation or other problems.)

How to drain the water

1 Close the shutoff valve. (Page 57)

2 Drain the pipe.
(Step **2** (1) to (4) on Page 54)

3 Pull out the water drain lever.
The water comes out from near the wand for about 20 seconds.

4 Release your hand to return the water drain lever to its original position.

5 Take appropriate measures for the water remaining in the bowl unit.

Putting antifreeze in the water remaining in the toilet bowl will reduce its chance of freezing.

■ To use the NEOREST again

- The water needs to be replenished. (Page 55)

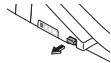
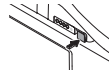

Troubleshooting

First, try the actions described on pages 57 to 64. If the problem persists, consult the installer, seller or the contact listed on the back cover of this manual.

- **All LEDs on the display of the top unit are flickering.**
(Unplug the power plug or turn off the breaker of the distribution board and contact where to call shown on the back cover.)
- **The CLEAN indicator does not light up.** (It is time for parts replacement. → Page 63)
- **The POWER LED (orange) and ENERGY SAVER LED (orange) on the main display are flashing.** (It is time for parts replacement. → Page 64)

CAUTION

! If a water leak occurs, close the shutoff valve.

Please check first

Is the **POWER LED** lit?

- **Does the LED light up when you press [POWER ON/OFF] on the top unit?**
- **Is the [POWER ON/OFF] flashing?**
→ Anti Freezing setting is "ON" (Page 48, 54)
- **Is the breaker on the distribution board turned on?**
→ Check whether there is a power outage or the breaker has turned "OFF".

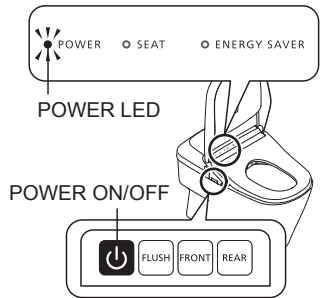

Is the **ENERGY SAVER LED** lit?

- **While the LED is lit, energy saver (Page 26) is in operation, so the toilet seat temperature may be reduced or the heater may be turned off.**

Is the remote control working?

- **Is the Low Battery Warning LED on the top surface of the remote control flashing?**
→ Replace the batteries. (Page 53)
- **Is the remote control transmitter or the remote control receiver blocked?**
→ Remove obstructions, dirt, water droplets or any other blockages.

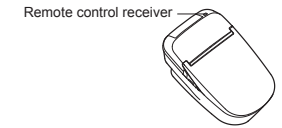
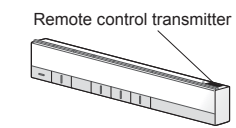
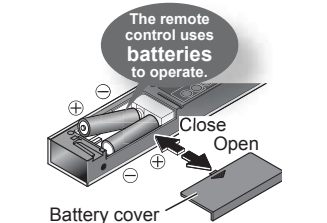

Troubleshooting

Rear and front cleansing, wand		
Trouble	Please check	Ref. Page
The wand (or cleansing water) does not come out	<ul style="list-style-type: none"> Can you operate with the control panel? (Check while sitting on the toilet seat.) → Check "Is the remote control working?" 	12 57
	<ul style="list-style-type: none"> When the temperature is low, it takes time for the wand to come out after the remote control button is pressed because the water must be warmed up first. 	-
	<ul style="list-style-type: none"> Did you sit on the toilet continuously for 2 hours or longer? (If so, operation is stopped for safety purposes.) → Stand up from the seat and then use again. 	-
	<ul style="list-style-type: none"> If the water supply pressure drops significantly, for example if water is used elsewhere or if there is a water failure, the function may stop for safety. → Disconnect the power plug and wait about 10 seconds before inserting it again. → Switch the breaker on the distribution board to OFF and wait about 10 seconds before inserting it again. (Asia, Oceania, Middle East) If the same symptom reappears → There may be a malfunction. Consult with the contact listed on the back cover of this manual. 	-
The wand extends but the cleansing water does not come out / The cleansing water pressure is weak	<ul style="list-style-type: none"> The seat sensor may have difficulty detecting some sitting postures. → Sit back on the toilet seat. 	11
	<ul style="list-style-type: none"> Are you using a toilet seat cover, a toilet lid cover or a seat for infants? → Remove any covers. When using a seat for infants or a soft highchair, remove after each use. 	11
	<ul style="list-style-type: none"> Has a water failure occurred? → Press the "STOP" button and wait until water service is restored. 	-
The cleansing water is cold	<ul style="list-style-type: none"> Is the shutoff valve closed? 	15
	<ul style="list-style-type: none"> Is the water filter drain valve clogged with foreign matter? → Clean the filter. 	33
	<ul style="list-style-type: none"> Is the water pressure set to a low level? 	16
Stops in the middle of use	<ul style="list-style-type: none"> Is the water temperature set to "OFF" or a low level? When the temperature of the water supply or the bathroom is low, the water temperature may be low when first sprayed. 	24
	<ul style="list-style-type: none"> Rear, rear soft, front and wide front cleansing stop automatically after 5 minutes of continuous use. Does the seat switch have difficulty detecting? → Sit back on the toilet seat. If you get up slightly from the seat, or sit forward on the seat, the seating switch may temporarily stop detecting your presence. 	- 11
Water comes out unexpectedly from the wand	<ul style="list-style-type: none"> Is the POWER LED (green) on the main display flashing? • The "ANTI FREEZING (Dynamic mode)" is set to "ON". (Water comes out from near the wand at 5-minute intervals and the bowl unit flushes at 10-minute intervals.) (SN993MX/TCF993WA only) 	54
	<ul style="list-style-type: none"> After pre-mist, water comes out from around the wand for a few seconds. Before after-mist, water comes out from around the wand for about 60 seconds. (SN993MX/TCF993WA only) Has the CLEAN indicator lit up in a cycle? • The wand is cleaned with "ewater+." 	20

Warm air drying		
Trouble	Please check	Ref. Page
The dryer temperature is low	<ul style="list-style-type: none"> Is the remote control preset temperature set to a low level? 	24
Stops in the middle of use	<ul style="list-style-type: none"> The feature stops automatically after 10 minutes of continuous use. Does the seat switch have difficulty detecting? → Sit back on the toilet seat. If you get up slightly from the seat, or sit forward on the seat, the seating switch may temporarily stop detecting your presence. 	- 11
Flushing		
Trouble	Please check	Ref. Page
The toilet does not flush even when the button is pressed	<ul style="list-style-type: none"> Are the LEDs flickering on the main display? • The tank is filling with water. (It takes about 60 sec at most.) 	-
	<ul style="list-style-type: none"> Is water available from the water supply? → Use a bucket full of water to flush. 	52
	<ul style="list-style-type: none"> Is the shutoff valve fully open? 	15
The bowl unit does not clean automatically or timing is delayed (auto bowl unit cleaning)	<ul style="list-style-type: none"> Is "AUTO FLUSH" set to "OFF"? → Set to "ON". Even if "AUTO FLUSH" is set to "ON", it is not available in the following instances. • 60 seconds after the toilet is flushed → After 60 seconds have passed, flush using the remote control. When the amount of time seated on or standing in front of toilet seat is about six seconds or less → Flush with the remote control. After using the toilet while standing and not moving away from the front of the toilet. → Step away from the toilet and wait for about three seconds. When water droplets or dirt are disrupting the body sensor. → Remove the dirt. 	40 22
	<ul style="list-style-type: none"> The seat sensor may have difficulty detecting some sitting postures. → Sit back on the toilet seat. 	11
	<ul style="list-style-type: none"> The timing for the auto bowl unit cleaning can be changed. (After about 10 seconds → after about 5 or 15 seconds) 	11 40
The toilet flushes on its own	<ul style="list-style-type: none"> Is "AUTO FLUSH" set to "ON"? Does the seat switch or the body sensor have difficulty turning on or detecting? → Sit back on the toilet seat. If you lift your hip off the toilet seat during use or sit forward on it, the seat switch may not turn on, and thus auto flushing may occur during use. → Remove any dirt that is on the body sensor. 	40 11
	<ul style="list-style-type: none"> Is the POWER LED (green) on the main display flashing? • The "ANTI FREEZING (Dynamic mode)" is set to "ON". (Water comes out from near the wand at 5-minute intervals and the bowl unit flushes at 10-minute intervals.) (SN993MX/TCF993WA only) 	54

Troubleshooting

Flushing		
Trouble	Please check	Ref. Page
Waste material does not flush down completely	● Is the shutoff valve fully open? → Clean the filter.	15
	● Is the water filter clogged? → Clean the filter.	36
	● Is the water supply to the toilet disrupted by other running water fixtures? → Cease using other fixtures and then flush the toilet.	-
	● Are the flush and light flush buttons being used correctly? • Flush (for solid waste): Up to 10 m of toilet paper (single) • Light flush (for liquid waste): Up to 3 m of toilet paper (single)	17
	● Flushing may be difficult depending on the consistency of the waste material. → Flush the toilet again. If the bowl unit is not cleansed with a flushing, remove the stains with a brush or similar instrument.	-
	● When the tank is filling, you cannot flush the toilet. → Once the main display "Power" LEDs are lit and the tank fills up with water, flush the toilet.	-
There is residue on the bowl unit surface	● Oil and other hard-to-see grime may stick to the bowl unit surface. → Clean the bowl with (non-abrasive) neutral toilet detergent.	32

Toilet Seat and Toilet Lid (AUTO OPEN/CLOSE)		
Trouble	Please check	Ref. Page
The toilet lid does not open automatically	● Is "AUTO OPEN/CLOSE (LID)" set to "OFF"? → Set to "ON".	42
	● Does the body sensor have difficulty detecting? → Remove any dirt that is on the body sensor.	11
	● Even when set to "ON", AUTO OPEN/CLOSE (LID) is not performed for about 15 seconds after the toilet seat or toilet lid is closed. • When the toilet lid is closed by hand (To make the NEOREST more user-friendly, a time interval is set from when the lid is closed to when it will open next.) → Leave the bathroom, and then after 15 seconds or more, approach the bowl unit.	22
	● Detection may be difficult when the room temperature exceeds 30°C, such as in the summertime. → Open and close manually.	11
	● Is "AUTO OPEN WAITING TIME" set to 30s or 90s?	42
The toilet lid does not close automatically	● After the power plug is inserted (after the breaker on the distribution board is turned to "ON" (Asia, Oceania, Middle East)), the toilet lid does not open automatically for about 10 to 60 seconds. → Open and close by hands.	-
	● Is a toilet seat or lid cover installed? → Remove any covers.	11
	● Is "AUTO OPEN/CLOSE (LID)" set to "OFF"? → Set to "ON".	42
The toilet lid does not close automatically	● When you do not sit on the toilet seat, or when the time spent sitting on the toilet seat or standing in front of it is 6 seconds or less, the toilet seat and toilet lid close after about 5 minutes.	22
	● If they do not close automatically even though "AUTO OPEN/CLOSE (LID)" is set to "ON", the body sensor may be detecting incorrectly. → If there is a reflective object in front, such as a mirror or glass, move the reflective object or use a curtain or other object to block it.	11

Toilet Seat and Toilet Lid (AUTO OPEN/CLOSE)		
Trouble	Please check	Ref. Page
The toilet lid opens on its own	● Is the sensor directly exposed to sunlight? → Do not directly expose the sensor to sunlight, because it may cause incorrect detection. ● Is there a heater within the detection range of the body sensor? → Do not place within the detection range of the sensor. ● Is a urinal or wash basin also installed in the bathroom? → The sensor may detect someone using the urinal, causing the toilet lid to open or close.	11
The toilet lid closes on its own	● Is "AUTO OPEN/CLOSE (LID)" set to "ON"? ● Is AUTO CLOSE WAITING TIME set to 25s? ● The seat switch may have difficulty detecting some sitting postures. → Sit back on the toilet seat.	42 11
The toilet lid and toilet seat open at the same time	● Are the settings configured to open the toilet lid and toilet seat at the same time?	42
Stops (or closes) while opening	● If the lid or seat hits an obstruction the first time it opens after inserting the power plug, it may stop (or close) partway during the next operation. → While there are no obstructions, disconnect the plug and insert it again after about 5 seconds. Then press the "OPEN/CLOSE (Seat)" button on the remote control. ● If the lid or seat hits an obstruction the first time it opens after switching ON the breaker on the distribution board, it may stop (or close) partway during the next operation. (Asia, Oceania, Middle East) → Eliminate any obstructions and switch the breaker on the distribution board to OFF. Switch it to ON again after about 5 seconds. Then press the "OPEN/CLOSE (Seat)" button on the remote control. (Asia, Oceania, Middle East)	-
The open timing has changed	● Detection by the body sensor may be difficult when the room temperature exceeds 30°C, such as in the summertime.	11
Cannot open or close with the remote control	● If it opens automatically → Check "Is the remote control working?" ● Incorrect detection may occur when operating under fluorescent lights.	57 -

Troubleshooting

Toilet Seat and Toilet Lid		
Trouble	Please check	Ref. Page
The toilet seat does not get warm	● Is the toilet seat temperature set to "OFF" or a low level? →Set to "ON".	24
	● Is the ENERGY SAVER LED (green) lit? • Timer energy saver is operating and has turned off the toilet seat heater. →When you sit on the seat, the heater is turned on temporarily and the seat is warmed in about 15 minutes. ● Is the ENERGY SAVER LED (orange) lit? • The toilet seat temperature has been lowered to save energy (the auto energy saver in operation). →When you sit on the seat, the heater is turned on temporarily and the seat is warmed in about 15 minutes.	26
	● Have you been seated for a long time? • After about 20 minutes of sitting, the temperature starts going down, and after about 1 hour, the heater is turned "OFF". →Move away from the toilet seat and then go back.	-
	● The seat switch may have difficulty detecting some sitting postures. →Sit back on the toilet seat.	11
	● Is a toilet lid or seat cover installed? →Remove any covers.	11

Energy Saver		
Trouble	Please check	Ref. Page
The timer energy-saver feature is not working	● Did you replace the remote control batteries? • When the batteries are discharged, the settings may be erased. →Reconfigure the setting.	14 26
The auto energy-saver feature is not working	● Because the function takes several days learning the usage conditions before starting energy saver, the amount of energy saving may be low, depending on the frequency of use. →Check the type of energy saver.	26

Deodorizer		
Trouble	Please check	Ref. Page
The deodorizer seems to be not working	● Even after sitting down, you do not hear operation sounds. →Sit back on the toilet seat.	11
	● If you hear an operation sound when you sit on the toilet seat. →Clean the deodorizing filter.	34
A strange odor is emitted	● Are you using an air freshener or deodorizer that you purchased separately? • Doing so may reduce the effectiveness of the NEOREST deodorizer or cause strange odors. →Remove the air freshener or deodorizer.	-
The deodorizer is not working	● Is "DEODORIZER" set to "OFF"? →Set to "ON".	44

Sanitary		
Trouble	Please check	Ref. Page
The soft light or bowl light does not light up	● Is the setting "OFF"? →Set to "ON".	46
The mist sprays out spontaneously	● When body sensor A detects someone, the pre-mist is sprayed.	11
	● When the cleansing functions have not been used in 8 hours, mist is sprayed inside the bowl unit automatically.	20
The UV lamp illuminates the inside of the toilet bowl. (SN993MX / TCF993WA only)	● When the "ANTI FREEZING (Dynamic mode)" is set to "ON", after-mist is sprayed at intervals of 5 minutes.(TCF993WA only)	54
	● When the cleansing functions have not been used in 10 hours, the UV lamp lights up.	20
The CLEAN indicator does not light up	● Is the setting "OFF"? →Set to "ON".	46
	● If the CLEAN indicator does not light up, it is time for parts replacement. Consult with us (See the contact information on the back cover).	Back cover
The toilet bowl surface repels water or tends to get dirty (SN993MX / TCF993WA only)	● The toilet bowl surface needs to be cleaned. →Clean with a toilet brush or the like using commercially available hydrochloric acid-based or inorganic acid-based detergent. • For daily cleaning, use neutral detergent. ● Is "AUTO OPEN/CLOSE(LID)" set to "OFF"? →When AUTO OPEN/CLOSE is set to "OFF" UV light does not work while the lid is open.	32

Troubleshooting

Others		
Trouble	Please check	Ref. Page
Water is leaking from the plumbing connections	<ul style="list-style-type: none"> If any nuts in a connection are loose, firmly tighten them with a tool such as a monkey wrench. →If the water leak does not stop, close the shutoff valve and seek repair. 	-
The display on the remote control goes out	<ul style="list-style-type: none"> The display goes out when no button on the remote control is pressed for 1 minute or more. 	14 17
The top unit is unstable	<ul style="list-style-type: none"> There is clearance between the toilet seat cushion and the bowl unit for activating the seat switch. When you sit on the toilet seat, the toilet seat subsides slightly to activate the seat switch. 	11
The top unit makes a sound	<p><When moving away from the bowl unit after use></p> <ul style="list-style-type: none"> You may hear the sound of the remaining water being drained. The sound of the fan rotating to ventilate the product is heard. (For about 30 minutes) <p><When not using the product></p> <ul style="list-style-type: none"> When the cleaning feature is not used for about 8 hours, you may hear the sound of auto wand cleaning. 	- 20
Water splashes up when using the toilet	<ul style="list-style-type: none"> The water in the bowl unit that is used to mask the smell of excrement is the cause of the splashing. →Adding a layer of toilet paper on the surface of the water can slightly dampen splashing. 	-
When cleansing, you hear a squishing sound underneath the floor	<ul style="list-style-type: none"> Flush the toilet and check for sounds coming from the discharge pipe. Use a device that maintains the necessary toilet water level. 	-
When flushing, you hear a gurgling sound	<ul style="list-style-type: none"> When the toilet is flushed together with waste material, the sound is a result of air, waste material and water being pulled through the system. 	-
The lamps on the main display are flashing (SN993MX / TCF993WA only)	<ul style="list-style-type: none"> When the POWER LED (orange) and ENERGY SAVER LED (orange) on the main display are flashing, it is time for parts replacement. Consult with us (See the contact information on the back cover). 	Back cover

Specifications

Item		TCF993WA/TCF992WA	SN993MX/992M	
Rated power supply		AC 220 - 240V, 50Hz/60Hz	AC 120V, 60Hz	
Rated power consumption		841-851W ²	1300W	
Maximum power consumption		1286-1524W		
Type		Instantaneous		
Power cord length		1.2m		
Water protection level		IPX4		
Bowl unit	Flush volume	Flush: 3.8L, Light flush: 3.0L		
	Water supply system	Concealed tank system		
	Flush type	Cyclone flushing		
	Bowl Style	Elongated		
Anti freezing	Dynamic type	Flush volume (dynamic)	38.9L/h/32.4L/h	
Functions	Cleansing	Rear cleansing	Approx. 0.27 to 0.43 L/min. <at 0.20 MPa water pressure>	
		Rear soft cleansing	Approx. 0.32 to 0.43 L/min. <at 0.20 MPa water pressure>	
		Front cleansing	Approx. 0.29 to 0.43 L/min. <at 0.20 MPa water pressure>	
		Wide front cleansing	Approx. 0.35 to 0.43 L/min. <at 0.20 MPa water pressure>	
		Water temperature	Adjustable temperature range: OFF, about 30°C to 40°C	
		Heater capacity	1200-1428W	1332W
		Safety device	Temperature fuse	
		Backflow prevention device	Vacuum breaker, Check valve	
	Warm air dryer	Warm air temperature ^{*1}	Adjustable temperature range : About 35°C to 55°C	
		Airflow volume	Approx. 0.29m ³ /min.	
		Heater capacity	200-238W	347W
	Heated seat	Safety device	Temperature fuse	
		Surface temperature	Adjustable temperature range: OFF, about 28°C to 36°C (About 26°C when auto energy saver is in operation)	
		Heater capacity	55-65W	60W
Deodorizer	Safety device	Temperature fuse		
	Method	O ₂ deodorization		
	Airflow volume	Approx. 0.16 m ³ /min.		
	Power consumption	Approx. 5.3W		
Water supply pressure		Minimum required water pressure: 0.05MPa (dynamic, 10L/m or more), Maximum required water pressure: 0.75MPa (static)		
Water supply temperature		0°C to 35°C		
Working ambient temperature		0°C to 40°C		
Dimensions		W 448mm x D 820mm x H 527mm		
Weight		About 56kg (Top unit: about 8kg, bowl unit: about 48kg)		

*1 Temperature around the warm air outlet measured by TOTO.

*2 Based on IEC60335-1 and 60335-2-84, rated power consumption shall be that of ambient temperature of 20°C and water supply temperature of 15°C.

Limited Warranty SN993MX/992M (MS993CUMFX/992CUMFG)

Three Year Limited Warranty

- TOTO warrants its Neorest brand product to be free from defects in materials and workmanship during normal use when properly installed and serviced, for a period of three (3) years from date of purchase. This limited warranty is extended only to the ORIGINAL PURCHASER of the Product and is not transferable to any third party, including but not limited to any subsequent purchaser or owner of the Product. This warranty applies only to TOTO Product is purchased and installed in North, Central and South America.
- TOTO's obligations under this warranty are limited to repair, replacement or other appropriate adjustment, at TOTO's option, of the Product or parts found to be defective in normal use, provided that such Product was properly installed, used and serviced in accordance with instructions.
TOTO reserves the right to make such inspections as may be necessary in order to determine the cause of the defect. TOTO will not charge for labor or parts in connection with warranty repairs or replacements. TOTO is not responsible for the cost of removal, return and/or reinstallation of the Product.
- This warranty does not apply to the following items:
 - Damage or loss sustained in a natural calamity such as fire, earthquake, flood, thunder, electrical storm, etc.
 - Damage or loss resulting from any accident, unreasonable use, misuse, abuse, negligence, or improper care, cleaning, or maintenance of the Product.
 - Damage or loss resulting from sediments or foreign matter contained in a water system.
 - Damage or loss resulting from the quality of water in the region where the product is used.
 - Damage or loss resulting from improper installation or from installation of the Product in a harsh and/or hazardous environment, or improper removal, repair or modification of the Product. This includes locations where the water pressure is above local codes or standards. (NOTE : Product model codes allow a maximum of 80 PSI. Check local codes or standards for requirements).
 - Damage or loss resulting from electrical surges or lightning strikes or other acts which are not the fault of TOTO or which the Product is not specified to tolerate, including failure to use the factory equipped cord and plug or use of a loose or faulty electrical outlet or use of a current or socket other than a 120V, 60Hz electrical current from a GFI (ground, fused) socket.
 - Damage or loss resulting from normal and customary wear and tear, such as gloss reduction, scratching or fading over time due to use, cleaning practices or water or atmospheric conditions, including but not limited to, the use of bleach, alkali, acid cleaners, dry (powder) cleaners or any other abrasive cleaners or the use of metal or nylon scrubbers.
- If the Danger Label which has been placed over the seams on the back of the Product's top unit is broken or otherwise not intact, this limited warranty is void.
- In order for this limited warranty to be valid, proof of purchase is required. TOTO encourages warranty registration upon purchase to create a record of Product ownership at <http://www.totousa.com>. Product registration is completely voluntary and failure to register will not diminish your limited warranty rights.
- If the Product is used commercially or is installed outside of North, Central or South America, TOTO warrants the Product to be free from defects in materials and workmanship during normal use for one (1) year from the date of installation of the Product, and all other terms of this warranty shall be applicable except the duration of the warranty.
- This warranty gives you specific legal rights. You may have other rights which vary from state to state, province to province or country to country.
- To obtain warranty repair service under this warranty, you must take the Product or deliver it prepaid to a TOTO service facility together with proof of purchase (original sales receipt) and a letter stating the problem, or contact a TOTO distributor or products service contractor, or write directly to TOTO U.S.A., INC., 1155 Southern Road, Morrow, GA 30260 (888) 295 8134 or (678) 466-1300, if outside the U.S.A. If, because of the size of the Product or nature of the defect, the Product cannot be returned to TOTO, receipt by TOTO of written notice of the defect together with proof of purchase (original sales receipt) shall constitute delivery. In such case, TOTO may choose to repair the Product at the purchaser's location or pay to transport the Product to a service facility.
WARNING! TOTO shall not be responsible or liable for any failure of, or damage to, this Product caused by either chloramines in the treatment of public water supply or cleaners containing chlorine (calcium hypochlorite).
NOTE: The use of a high concentrate chlorine or chlorine related product's can seriously damage the fittings. This damage can cause leakage and serious property damage.
THIS WRITTEN WARRANTY IS THE ONLY WARRANTY MADE BY TOTO. REPAIR, REPLACEMENT OR OTHER APPROPRIATE ADJUSTMENT AS PROVIDED UNDER THIS WARRANTY SHALL BE THE EXCLUSIVE REMEDY AVAILABLE TO THE ORIGINAL PURCHASER. TOTO SHALL NOT BE RESPONSIBLE FOR LOSS OF THE PRODUCT OR FOR OTHER INCIDENTAL, SPECIAL OR CONSEQUENTIAL DAMAGES OR EXPENSES INCURRED BY THE ORIGINAL PURCHASER, OR FOR LABOR OR OTHER COSTS DUE TO INSTALLATION OR REMOVAL, OR COSTS OF REPAIRS BY OTHERS, OR FOR ANY OTHER EXPENSE NOT SPECIFICALLY STATED ABOVE. IN NO EVENT WILL TOTO'S RESPONSIBILITY EXCEED THE PURCHASE PRICE OF THE PRODUCT. EXCEPT TO THE EXTENT PROHIBITED BY APPLICABLE LAW, ANY IMPLIED WARRANTIES, INCLUDING THAT OF MERCHANTABILITY OR FITNESS FOR USE OR FOR A PARTICULAR PURPOSE, ARE EXPRESSLY DISCLAIMED. SOME STATES DO NOT ALLOW LIMITATIONS ON HOW LONG AN IMPLIED WARRANTY LASTS, OR THE EXCLUSION OR LIMITATION OF INCIDENTAL OR CONSEQUENTIAL DAMAGES, SO THE ABOVE LIMITATION AND EXCLUSION MAY NOT APPLY TO YOU.

Warranty TCF993WA/992WA <Bowl unit: CW993VA/CW992VA>

LIMITED ONE YEAR WARRANTY

- TOTO warrants its products to be free from manufacturing defects under normal use and service for a period of one (1) year from the date of purchase. This warranty is extended only to the ORIGINAL PURCHASER.
- TOTO's obligations under this warranty are limited to repair or replacement, at TOTO's option, of products or parts found to be defective, provided that such products were properly installed and used in accordance with this OWNER'S MANUAL. TOTO reserves the right to make such inspections as may be necessary to determine the cause of the defect. TOTO will not charge for labor or parts in connection with warranty repairs or replacements.
TOTO is not responsible for the cost of removal, return and/or reinstallation of products.
- This warranty does not apply to the following items:
 - Damage or loss sustained in a natural calamity such as fire, earthquake, flood, thunder, electrical storm, etc.
 - Damage or loss resulting from any unreasonable use, misuse, abuse, negligence, or improper maintenance of the product.
 - Damage or loss resulting from removal, improper repair, or modification of the product.
 - Damage or loss resulting from sediments or foreign matter contained in a water system.
 - Damage or loss resulting from the quality of water in the region where the product is used.
 - Damage or loss resulting from improper installation or from installation of a unit in a harsh and/or hazardous environment.
 - Damage or loss resulting from electrical surges or lightning strikes or other acts which are not the fault of TOTO or which the product is not specified to tolerate.
 - Damage or loss resulting from normal and customary wear and tear, such as gloss reduction, scratching or fading over time due to use, cleaning practices or water or atmospheric conditions.
- This warranty gives you specific legal rights. You may have other rights which vary from country to country.
- To obtain warranty repair service under this warranty, you must take the product or deliver it prepaid to a TOTO service facility, together with a letter stating the problem, or contact a TOTO distributor or product service contractor, or directly to TOTO sales office. If, because of the size of the product or nature of the defect, the product can not be returned to TOTO, receipt by TOTO of written notice of the defect shall constitute delivery. In such case, TOTO may choose to repair the product at the purchaser's location or pay to transport the product to a service facility.

WARNING! TOTO shall not be responsible or liable for any failure of, or damage to, this Product caused by either chloramines in the treatment of public water supply or cleaners containing chlorine (calcium hypochlorite).
NOTE: The use of a high concentrate chlorine or chlorine related product's can seriously damage the fittings. This damage can cause leakage and serious property damage.

THIS WRITTEN WARRANTY IS THE ONLY WARRANTY MADE BY TOTO. REPAIR OR REPLACEMENT AS PROVIDED UNDER THIS WARRANTY SHALL BE THE EXCLUSIVE REMEDY AVAILABLE TO THE PURCHASER. TOTO SHALL NOT BE RESPONSIBLE FOR LOSS OF USE OF THE PRODUCT OR FOR OTHER INCIDENTAL, SPECIAL, OR CONSEQUENTIAL DAMAGE OR EXPENSES INCURRED BY PURCHASER, OR FOR LABOR OR OTHER COSTS DUE TO INSTALLATION OR REMOVAL, OR COSTS OF REPAIRS BY OTHERS, OR FOR ANY OTHER EXPENSE NOT SPECIFICALLY STATED ABOVE. EXCEPT TO THE EXTENT PROHIBITED BY APPLICABLE LAW, ANY IMPLIED WARRANTIES, INCLUDING THAT OF MERCHANTABILITY OR FITNESS FOR USE, ARE EXPRESSLY LIMITED TO THE DURATION OF THIS WARRANTY. SOME STATES DO NOT ALLOW LIMITATIONS ON HOW LONG AN IMPLIED WARRANTY LASTS, OR THE EXCLUSION OR LIMITATION OF INCIDENTAL OR CONSEQUENTIAL DAMAGE, SO THE ABOVE LIMITATION AND EXCLUSION MAY NOT APPLY TO YOU.